

Packard Bell oneTwo M3350 / oneTwo M3351 / oneTwo L5350 / oneTwo L5351 All-In-One Computer Service Guide

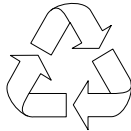

100% Recycled Paper

Service guide files and updates are available
on the Acer/CSD web site; for more
information, go to <http://csd.acer.com.tw>

Revision History

Refer to the table below for changes made on this version of the Packard Bell oneTwo M3350 / oneTwo M3351 / oneTwo L5350 / oneTwo L5351 All-In-One Computer Service Guide.

Date	Chapter	Updates

Copyright

Copyright © 2010 by Acer Incorporated. All rights reserved. No part of this publication may be reproduced, transmitted, transcribed, stored in a retrieval system, or translated into any language or computer language, in any form or by any means, electronic, mechanical, magnetic, optical, chemical, manual or otherwise, without the prior written permission of Acer Incorporated.

Disclaimer

The information in this guide is subject to change without notice.

Acer Incorporated makes no representations or warranties, either expressed or implied, with respect to the contents hereof and specifically disclaims any warranties of merchantability or fitness for any particular purpose. Any Acer Incorporated software described in this guide is sold or licensed "as is". Should the programs prove defective following their purchase, the buyer (and not Acer Incorporated, its distributor, or its dealer) assumes the entire cost of all necessary servicing, repair, and any incidental or consequential damages resulting from any defect in the software.

Acer is a registered trademark of Acer Incorporated.

Other brand and product names are trademarks and/or registered trademarks of their respective holders.

Conventions

The following textual conventions are used in this service guide.

SCREEN MESSAGES	Denotes actual messages that appear on screen.
NOTE	Gives additional information related to the current topic.
WARNING	Alerts you to any physical risk or system damage that might result from doing or not doing specific actions.
CAUTION	Gives precautionary measures to avoid possible hardware or software problems.
IMPORTANT	Reminds you to do specific actions relevant to the accomplishment of procedures.

Service Guide Coverage

This Service Guide provides you with all technical information relating to the BASIC CONFIGURATION decided for our "global" product offering. To better fit local market requirements and enhance product competitiveness, your regional office MAY have decided to extend the functionality of a machine (e.g. add-on card, modem, or extra memory capability). These LOCALIZED FEATURES will NOT be covered in this generic service guide. In such cases, please contact your regional offices or the responsible personnel/channel to provide you with further technical details.

FRU Information

Please note WHEN ORDERING FRU PARTS, that you should check the most up-to-date information available on your regional web or channel. If, for whatever reason, a part number change is made, it will not be noted in the printed service guide. For AUTHORIZED SERVICE PROVIDERS, your office may have a DIFFERENT part number code to those given in the FRU list of this printed service guide. You MUST use the list provided by your regional Acer office to order FRU parts for repair and service of customer machines.

Table of Contents

Chapter 1 – Features and Specifications	1
System Features	1
Physical Specifications	2
System Tour	3
Front View	3
Left View	4
Right View	5
Rear View	6
Hardware Specifications	7
Processor	7
Chipsets	7
BIOS	7
Memory	8
Hard Disk Drive	8
Optical Disc Drive	8
Ethernet	9
Wireless LAN	9
Bluetooth	9
Audio	9
Webcam	9
LCD Panel	10
Power Supply Unit	10
Chapter 2 – System Utilities	11
CMOS Setup Utility	11
Accessing the Setup Utility	12
Navigating through the Setup Utility	13
Setup Utility Menus	13
Chapter 3 – System Disassembly	25
Disassembly Tools	25
Pre-disassembly Procedure	25
Disassembly Procedures	26
Removing the Computer Stand	26
Removing the I/O Cable Cover	27
Removing the Rubber Feet	27
Removing the Rear Cover	28
Removing the I/O Cable Plate	28
Removing the Optical Disc Drive	29
Removing the Scaler Board	31
Removing the USB/Audio Board	33
Removing the Wall Mount Plate	35
Removing the TV Tuner Card	36
Removing the Graphics Card	37
Removing the Hard Disk Drive	40
Removing the Inverter Board	42
Removing the Heat Sink Fan (HSF) Assembly	43
Removing the Processor	44
Removing the Memory Modules	46
Removing the RTC Battery	46
Removing the Mainboard	47

Table of Contents

Removing the Power Supply Unit	49
Removing the Touchscreen Control Board	51
Removing the Bluetooth Module	52
Removing the Power Button Assembly	53
Removing the LCD Assembly	54
Removing the Main Chassis	56
Removing the LCD Cable	58
Removing the LCD Board Cover	58
Removing the Webcam Module	59
Removing the Capacitive LED Board	59
Removing the Light Bars	60
Chapter 4 – Troubleshooting	61
Hardware Diagnostic Procedure	61
System Check Procedures	61
Checkpoints	62
POST Error Indicators	66
BIOS Recovery	77
Clearing CMOS	78
Chapter 5 – System Architecture	79
Block Diagram	79
Mainboard Layout	80
Chapter 6 – Field Replaceable Unit (FRU) List	83
Exploded Diagram	84
FRU List	85
Appendix A – Model Definitions and Configurations	94
Appendix B – Test Compatible Components	100
Approved Vendor List (AVL)	102
Appendix C – Online Support Information	110
Index	111

Features and Specifications

This chapter lists the features and specifications of the Packard Bell oneTwo M3350 / oneTwo M3351 / oneTwo L5350 / oneTwo L5351 AIO computer.

NOTE The items listed in this section are for reference only. The exact configuration of your PC depends on the model purchased.

System Features

Component	Description
Processor	<ul style="list-style-type: none"> • Socket AM3, 941 pin contacts • Supports the AMD Phenom™ II X3 or X4 Processors
Chipset	nVIDIA GeForce 8200 (MCP78PV)
Memory	<ul style="list-style-type: none"> • Number of DIMM slots: Four DDR3 DIMM slots • Maximum memory: 8 GB (using four 2 GB modules)
PCI expansion options	<ul style="list-style-type: none"> • One PCI Express x16 slot (for graphics card installation) • One PCI Express x1 slot (for TV tuner card installation)
Display	<ul style="list-style-type: none"> • ZX6350: 21.5-inch LCD panel • ZX6351: 21.5-inch LCD touchscreen panel • ZX4350: 23-inch LCD panel • ZX4351: 23-inch LCD touchscreen panel
Audio	<ul style="list-style-type: none"> • Two built-in 5W stereo speakers • Realtek ALC888S 7.1+2 Channel High Definition Audio Codec
I/O ports	<ul style="list-style-type: none"> • Right panel <ul style="list-style-type: none"> – USB ports (two) – Headphone jack – Microphone jack • Left panel <ul style="list-style-type: none"> – HD dual digital TV tuner (optional) – PS/2 keyboard and mouse ports – Line-in, line-out, and microphone jacks – Line-in and line-out jacks – USB ports (four) – eSATA port – Ethernet jack (RJ-45) – External display (VGA) port – Serial-to-DVI port (optional) – HDMI port – PS/2 keyboard and mouse ports
Media storage	<ul style="list-style-type: none"> • 3.5-inch 25.4 mm 5400/7200 rpm SATA hard disk drive (HDD) • Slim type SATA optical disc drive (ODD)
Card reader	<ul style="list-style-type: none"> • 9-in-1 card reader slot • Supports MultiMediaCard (MMC), Reduced-Size MultiMediaCard (RS-MMC), Secure Digital (SD), xD-Picture Card (xD), Secure Digital High Capacity (SDHC), Memory Stick (MS), Memory Stick PRO (MS PRO) cards, CompactFlash Type I and II (CF-I, CF-II), and microdrives

Component	Description
Connectivity	<ul style="list-style-type: none"> Wired LAN: Onboard 10/100/1000 Ethernet support WLAN option: Mini Card wireless network adapter (802.11 b/g/n) WPAN option: Bluetooth® 2.1+EDR (Enhanced Data Rate) Integrated 2.0 MP webcam
Power supply	220 W power supply unit with PFC or non-PFC option (power factor correction)
Operating system support	<ul style="list-style-type: none"> Microsoft Windows 7 (Home Premium x64/x86, Home Basic x86) FreeDOS Linux LL95
Antivirus software	Norton Internet Security
Security	<ul style="list-style-type: none"> BIOS-based user and supervisor passwords Kensington lock
Power management	ACPI 2.0-compliant

Physical Specifications

Aspect	Description
System dimension (W x H x D)	107 x 445 x 560 mm (4.21 x 17.52 x 22.05 in)
Mainboard form factor	Standard DTX
Mainboard dimensions (W x H)	200 x 244 mm

System Tour

The pictures and tables in this section illustrate the physical outlook of the computer.



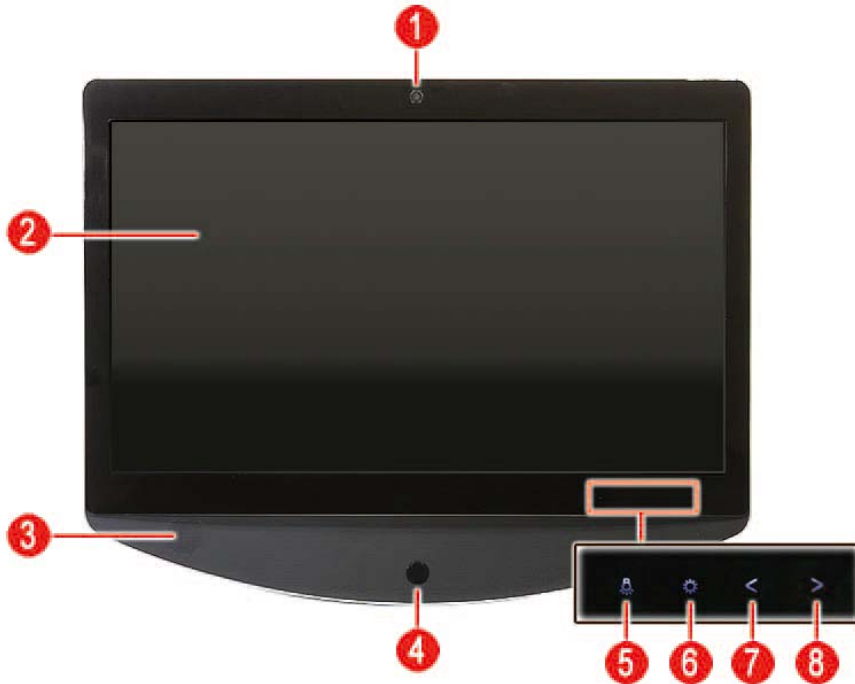





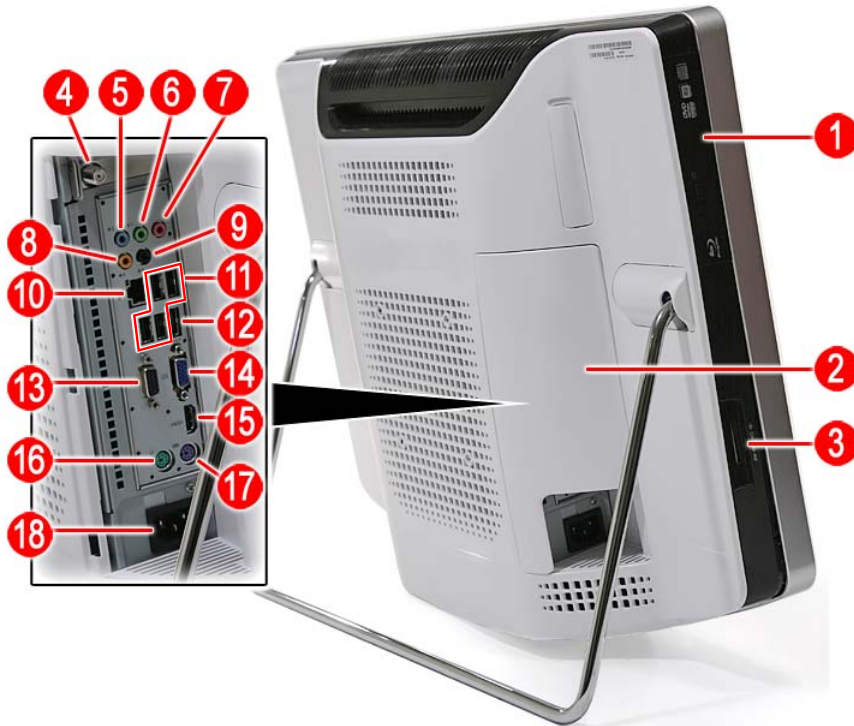

Front View



Item	Icon	Component
1		Integrated webcam
2		Display screen
3		Speakers
4		Power button/indicator <ul style="list-style-type: none">• Blue – System is in power-on mode• Flashing blue – System is in standby mode
5		Auxiliary lighting capacitive key
6		LCD brightness capacitive key
7		Decrease volume capacitive key
8		Increase volume capacitive key
NOTE: Icons for the capacitive keys are only visible when the system is turned on.		



Left View

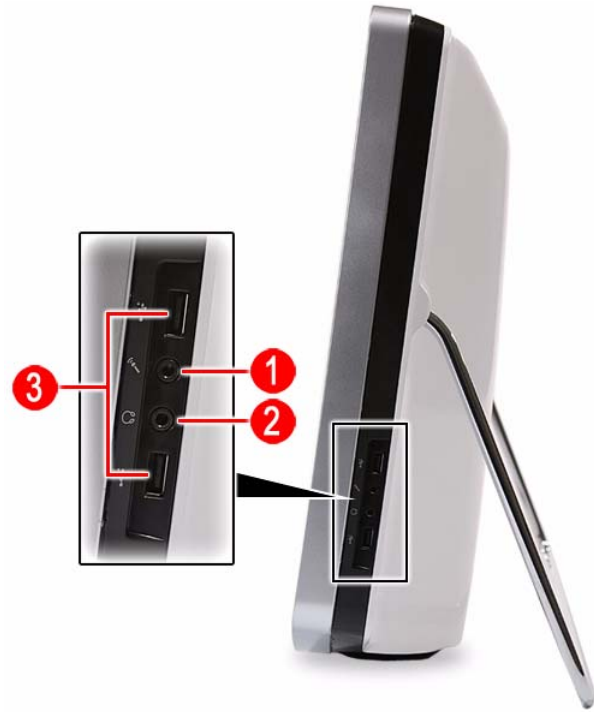

Item	Icon	Component	Item	Icon	Component
1		Optical disc drive (ODD)	10		Ethernet port (RJ-45)
2		I/O cable cover	11		USB ports
3		9-in-1 card reader	12		eSATA port
4		HD dual digital TV tuner (optional)	13		Serial-to-DVI port (optional)
5		Line-in jack	14		Monitor port
6		Line-out jack	15	HDMI	HDMI port
7		Microphone jack	16		PS/2 mouse port
8		Line-in jack	17		PS/2 keyboard port
9		Line-out jack	18		AC power jack

Right View



Item	Icon	Component
1		Microphone jack
2		Line-out jack
3		USB ports

Rear View

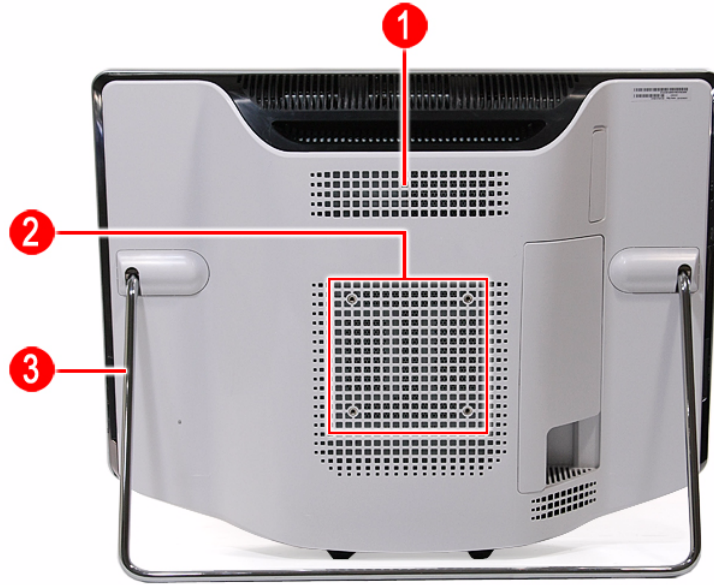

Item	Icon	Component
1		Ventilation slots
2		Mounting holes for wall mount option
3		Computer stand

Hardware Specifications

Processor

AMD Phenom II Processors

Item	Specification			
Series	X3		X4	
Model	700e	705e	900e	910e
Frequency	2.4 GHz	2.5 GHz	2.4 GHz	2.5 GHz
# of cores	3	3	4	4
L2 cache	1.5 MB	1.5 MB	2 MB	2 MB
L3 cache	6 MB	6 MB	6 MB	6 MB
Package type	45 nm	45 nm	45 nm	45 nm
Socket	Socket AM3	Socket AM3	Socket AM3	Socket AM3
Max TDP	65 W	65 W	65 W	65 W

AMD Athlon II Processors

Item	Specification					
Series	X2			X3	X4	
Model	215	240	245	405e	600e	605e
Frequency	2.7 GHz	2.8 GHz	2.9 GHz	2.3 GHz	2.2 GHz	2.3 GHz
# of cores	2	2	2	3	4	4
L2 cache	1 MB	2 MB	2 MB	1.5 MB	2 MB	2 MB
Package type	45 nm	45 nm	45 nm	45 nm	45 nm	45 nm
Socket	Socket AM3	Socket AM3	Socket AM3	Socket AM3	Socket AM3	Socket AM3
Max TDP	65 W	65 W	65 W	45 W	45 W	45 W

Chipsets

Item	Specification
System chipset	nVIDIA GeForce 8200 (MCP78PV)
I/O controller	SIO ITE 8720

BIOS

Item	Specification
BIOS chip	AMI BIOS
Setup utility	CMOS Setup Utility

Memory

Item	Specification
Controller	Integrated in the AMD processor
Number of DIMM slot	4
Maximum memory	8 GB (using four 2 GB modules)
Data rate	1333 MT/s
Supported capacities	1 or 2 GB
DIMM type	240-pin DDR3 SO-DIMM
Supported brands	A-Data, Apacer, Kingston, Transcend, Unifosa, Samsung
Population rule	You can install memory modules in any combination as long as they match the above specifications.

Hard Disk Drive

Item	Specification
Controller	Integrated in the nVIDIA GeForce 8200 (MCP78PV)
Form factor	3.5-inch 9.5 mm
Interface	SATA 2.0
Supported capacities	
320 GB	<ul style="list-style-type: none"> Seagate Pharaoh (7200 rpm) HGST HDT721032SLA380 (7200 rpm) WD WD1600AAJS-22L7 (7200 rpm)
500 GB	<ul style="list-style-type: none"> WD WD5000AAKS-22M9A0 (7200 rpm)
640 GB	<ul style="list-style-type: none"> Seagate ST3640623AS (7200 rpm) HGST HDT721064SLA360 (7200 rpm) WD WD6400AAKS-22A7B2 (7200 rpm)
1 TB	<ul style="list-style-type: none"> Seagate ST31000528AS (7200 rpm) HGST HDT721010SLA360 (7200 rpm) WD WD10EADS-22M4B0 (5400 rpm) / WD1001FALS-22J7B0 (7200 rpm)
1.5 TB	<ul style="list-style-type: none"> Seagate ST31500341AS (7200 rpm) WD WD15EADS-22P8B0 (5400 rpm)

Optical Disc Drive

Item	Specification
Controller	Integrated in the nVIDIA GeForce 8200 (MCP78PV)
Type	DVD-Super Multi double-layer or Blu-ray Disc combo drive option
Form factor	Slim type
Tray height (mm))	12.7 mm
Interface	SATA
Supported models	
DVD-Super Multi double-layer drive	<ul style="list-style-type: none"> HLDS GT31N PLDS DS-8A5SH
Blu-ray Disc combo drive	<ul style="list-style-type: none"> Panasonic UJ141AL/UJ240A HLDS CT21N

Ethernet

Item	Specification
Controller	Marvell 88E1116 Intel WG82567V Gigabit NIC
LAN protocol	10/100/1000 Mbps
LAN connector type	RJ-45

Wireless LAN

Item	Specification
Model	Lite-On WN6607LH
Protocol	802.11 b/g/n
Form factor	PCIe Mini Card

Bluetooth

Item	Specification
Model	<ul style="list-style-type: none">Lite-On WB111C-C1Xavi BC10B-04C1
Version	Bluetooth 2.1 + EDR

Audio

Item	Specification
Controller	Realtek ALC888S 7.1+2 Channel High Definition Audio Codec
Features	<ul style="list-style-type: none">Two built-in 5W stereo speakersRight panel audio jacks<ul style="list-style-type: none">Headphone jackMicrophone jackLeft panel audio jacks<ul style="list-style-type: none">Line-in, line-out, and microphone jacksLine-in and line-out jacks

Webcam

Item	Specification
Resolution	2.0 MP
Supported models	<ul style="list-style-type: none">Chicony CNFA21321004590LPark Orchid C04PL037FPrimax 50-704A4WNT8

LCD Panel

Item	Specification	
Model	ZX6350 and ZX6351	ZX4350 and ZX4351
Screen size (diagonal, inch)	21.5-inch	23-inch
Type	Wide XGA	
Resolution	1920 x 1080	
Backlight	CCFL	
Interface	LVDS	
Brightness (typical)	300 nits	
Display colors	16.7M	
Aspect ratio	16:9	
Contrast ratio	1000:1	
Response time (typical)	5 ms	
Touchscreen	<ul style="list-style-type: none"> • ZX6350: Yes • ZX6351: No 	<ul style="list-style-type: none"> • ZX4350: Yes • ZX4351: No
Surface treatment	AG type, 3H hard coating, Haze 25	
Supported models	•	<ul style="list-style-type: none"> • LG LM230WF1 • Samsung LTM230HT01 • E-Turbo SR-230M182235D1 (touch panel)
Inverter board	•	<ul style="list-style-type: none"> • Darfon VZ.13156.B01 • Sumida IV30260SPEC139

Power Supply Unit

Item	Specification
Output (max.)	220 W
Supported models	<ul style="list-style-type: none"> • Lite-On PS-5221-06A1 / PE-5221-08AP / PS-5221-9AE • Delta DPS-220UB-1 A / DPS-220UB A / DPS-220UB-2 B • Chicony CPB09-D220R / CPB09-D220A / CPB09-D220E

System Utilities

CMOS Setup Utility

CMOS Setup Utility is a hardware configuration program built into the system ROM. Since most systems are already properly configured and optimized, there is normally no need to run this utility.

You will need to run this utility under the following conditions:

- When changing the system configuration including:
 - Setting the system time and date
 - Configuring the system drives and peripherals
 - Specifying the boot device sequence
 - Configuring the power management modes
 - Setting up system passwords or making other changes to the security setup
- When trying to resolve IRQ conflicts
- When a configuration error is detected by the system and you are prompted ("**Run Setup**" message) to make changes to the BIOS settings.

The Setup Utility loads the configuration values in a battery-backed nonvolatile memory called CMOS RAM. This memory area is not part of the system RAM, which allows configuration data to be retained when power is turned off. The values take effect when the system is booted. POST uses these values to configure the hardware. If the values and the actual hardware do not agree, POST generates an error message. You must run this utility to change the hardware settings from the default or current configuration.

IMPORTANT If you repeatedly receive "**Run Setup**" messages, the RTC battery located on the mainboard (BT1) may be defective. In this case, the system cannot retain configuration values in CMOS. Replace the RTC battery with a new one.

NOTE For ease of reading, CMOS Setup Utility will be simply referred to as "Setup" or "Setup Utility" in this Service Guide.

Accessing the Setup Utility

1. Turn on the computer.

If the computer is already turned on, save your data and close all open applications, then restart the computer.

2. During POST, press **Delete**.

If you fail to press **Delete** before POST is completed, you will need to restart the computer.

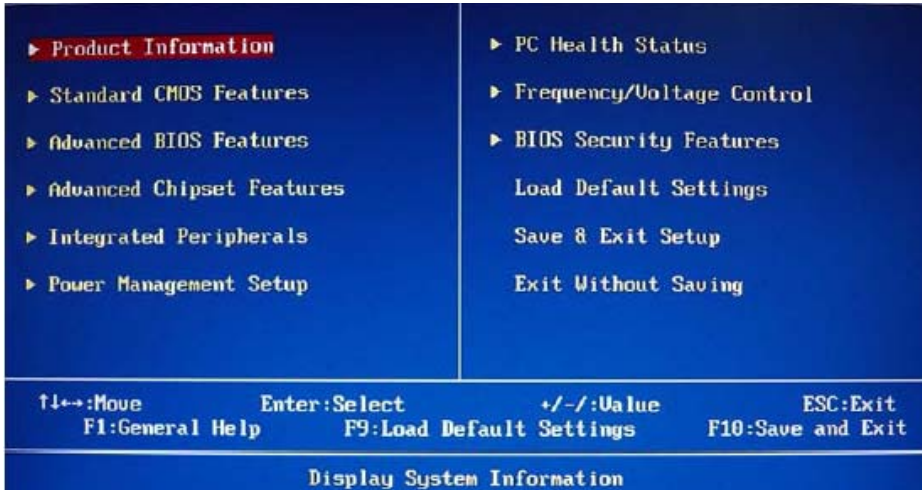

Use the **Up/Down/Left/Right** arrow keys to move between the menu options, then press **Enter** to execute that option.

Some options lead to pop-up dialog boxes that prompt you to verify that you wish to execute that option. Other options lead to dialog boxes that prompt you for information.

Some options (marked with a ►) lead to submenus that enable you to change the values for the option. Use the **Up/Down/Left/Right** arrow keys to scroll through the items in the submenu

Navigating through the Setup Utility

Use the keys listed in the legend bar on the bottom of the Setup screen to work your way through the various menu and submenu screens of the Setup Utility. The table below lists these legend keys and their respective functions.

Key	Function
Up/Down/Left/Right arrow keys	Move the cursor to the menu/field you want. The currently selected field will be highlighted.
Enter	<ul style="list-style-type: none">To open the page for the currently selected menu/submenuTo apply a field value.
PgUp and PgDn	Move the cursor to the previous and next page of a multipage menu.
Home	Move the cursor to the first page of a multipage menu.
End	Move the cursor to the last page of a multipage menu.
+ and -	To select a value for the currently selected field (only if it is user-configurable). Press these keys repeatedly to display all possible entries. A parameter that is enclosed in square brackets [] is user-configurable. Grayed-out parameters are not user-configurable for one of the following reasons: <ul style="list-style-type: none">The field value is auto-configured or auto-detected.The field value is informational only.The field is password-protected.
Esc	If you press this key: <ul style="list-style-type: none">On one of the primary menu screens, the <u>Exit</u> menu displays.On a submenu screen, the previous screen displays.When you are making selections from a pop-up menu, closes the pop-up without making a selection.
F1	To bring up the <u>General Help</u> window. The <u>General Help</u> window describes other Setup navigation keys that are not displayed on the legend bar.
F9	Press to load default system values.
F10	Press to save changes and close the Setup Utility.

Setup Utility Menus

The Setup Utility has twelve menus for configuring the various system functions. These include:

- Product Information
- Standard CMOS Features
- Advanced BIOS Features
- Advanced Chipset Features
- Integrated Peripherals
- Power Management Setup
- PC Health Status
- Frequency/Voltage Control
- BIOS Security Features
- Load Default Settings
- Save & Exit Setup
- Exit Without Saving

- NOTES**
- The screenshots used in this section are for illustration only. The values displayed may not be the same as those in your computer.
 - In the descriptive tables following each of the menu screen illustrations, settings in **boldface** are the default and suggested settings.

Product Information

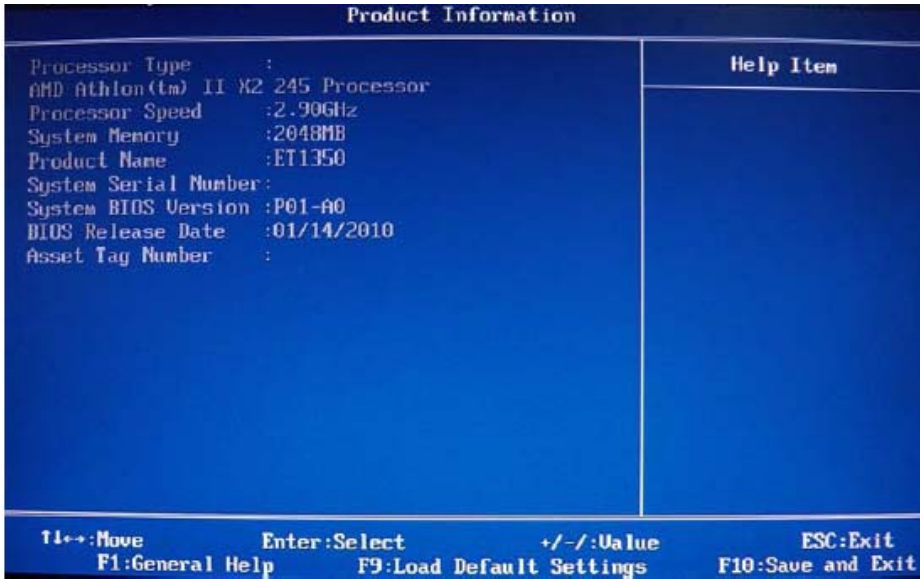

Field	Description
Processor Type	Type of processor installed on the system
Processor Speed	Speed of the processor installed on the system
System Memory	Size of system memory detected during boot-up
Product Name	Official model name of the computer.
System Serial Number	System serial number.
System BIOS Version	Current system BIOS version
BIOS Release Date	Date when the CMOS setup utility was released.
Asset Tag Number	System asset tag number

Standard CMOS Features

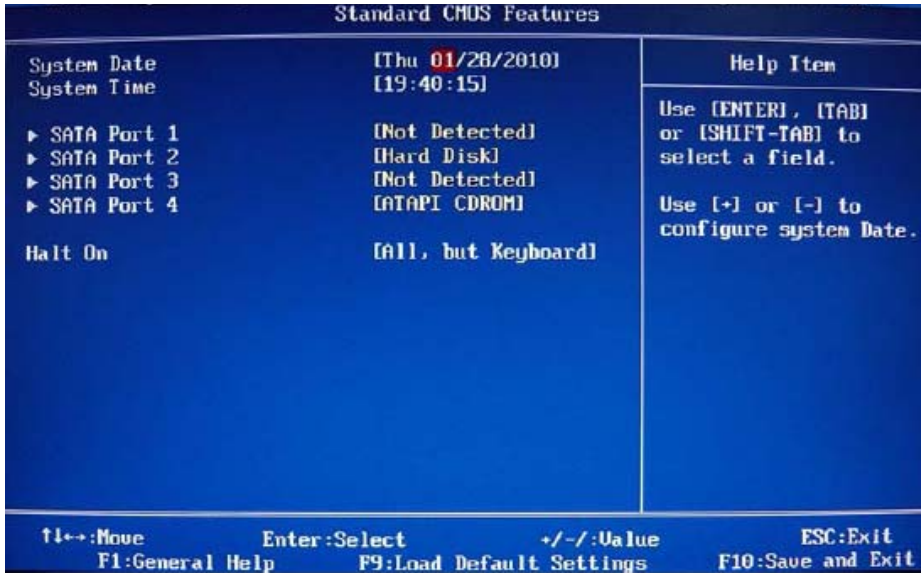

Field	Description	Value
System Date	Sets the system date.	MM/DD/YYYY (month/day/year)
System Time	Sets the system time.	HH:MM:SS (hour:minute:second)
AHCI Port 1–4	Your computer supports four SATA channels, each channel allows one SATA device to be installed. Press Enter to display the individual configuration screen of installed SATA drive(s).	
Halt On	Determines whether the system will stop for an error during the POST. Options include: <ul style="list-style-type: none"> All Errors - Any error detected will pause the system. No Errors - BIOS will ignore any errors detected during POST All, but Keyboard - If a keyboard error is detected, BIOS will pause the system. 	All Errors No Errors All, But Keyboard

Advanced BIOS Features



Field	Description	Value
Quick Boot	When enabled, the system starts up more quickly by elimination of some of the POST routines.	Enabled Disabled
Quiet Boot	When enabled, BIOS will show a full screen logo when booting; if disabled, BIOS will show the diagnostic POST screen when booting.	Enabled Disabled
1st/2nd/3rd/4th Boot Device	Displays the device assigned to the specified boot sequence. The Setup Utility attempts to boot the operating system in this order. By default, the computer searches for boot devices in the following order: <ul style="list-style-type: none"> • Hard disk • Optical drive (CD/DVD) • Removable device • Network boot (LAN) 	
Hard Disk Drive Priority	Press Enter to specify the boot device priority sequence for the installed hard drive(s).	
Optical Disk Drive Priority	Press Enter to specify the boot device priority sequence for the installed optical drive.	
Removable Device Priority	Press Enter to specify the boot device priority sequence for removable drives.	
Network Device Priority	Press Enter to specify the boot device priority sequence for available network drives.	
Bootup Num-Lock	If you set this item to On, the keyboard Num Lock key will be active when the computer boots up.	On Off
Boot Sector Virus Protection	If set to Disabled, when anything attempts to access the boot sector or hard disk partition table, there will be no warning message.	Enabled Disabled
USB Beep Message	Select whether to allow the BIOS to emit error beeps or display error messages during USB device enumeration.	Enabled Disabled

Advanced Chipset Features



Field	Description	Value
AMD Cool 'n' Quiet	Select whether to enable the AMD Cool 'N' Quiet Technology. This technology allows a compliant OS to dynamically adjust the system voltage and core frequency for reduced heat and noise emission.	Enabled Disabled
AMD-V	Select whether to enable the AMD-V Technology. This technology allows a single platform to run multiple operating systems in independent partitions.	Enabled Disabled
Memory Hole Remapping	When enabled, some or all of the memory between the 2 GB and 4 GB limits to addresses above 4 GB. This is a workaround for the PCI hole or PCI memory hole which is a limitation of 32-bit hardware and 32-bit operating systems that causes a computer to appear to have less memory available than is physically installed. Note: This feature is useful for systems running on 64-bit OS and those 32-bit systems that support the Physical Address Extension method.	Enabled Disabled
Hybrid SLI	Select whether to enable the Hybrid SLI technology when a nVIDIA graphics card is installed. Hybrid SLI increases graphics performance with GeForce® Boost and provides intelligent power management with HybridPower™.	Enabled Disabled
Primary Video	When a graphics card is installed, you have the option to select which graphics controller to activate. Note: When this field is set to Auto, the graphics controller priority sequence is: PCIe, Onboard, then PCI.	Auto PCIe Onboard PCI
UMA Frame Buffer Size	When a graphics card is installed, you can select how the system video memory (frame buffer) is allotted.	Auto 32 MB 64 MB 128 MB 256 MB
Current UMA Size	Displays the size of video memory (located in upper memory area—UMA) detected during boot-up.	

Integrated Peripherals

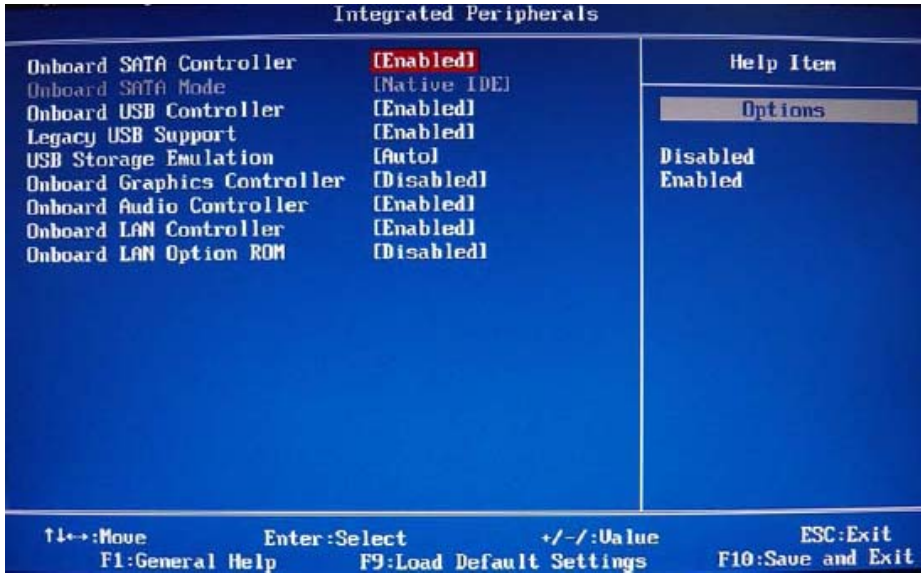

Field	Description	Value
Onboard SATA Controller	Enables or disables the onboard SATA controller.	Enabled Disabled
Onboard SATA Mode	Set the operating mode for the onboard SATA controller.	Native IDE
Onboard USB Controller	Enables or disables the onboard USB controller.	Enabled Disabled
Legacy USB Support	Enables or disables support for a USB mouse and USB keyboard. When enabled, any attached USB mouse or USB keyboard can control the system even when there is no USB driver loaded onto the system.	Enabled Disabled
USB Storage Emulation	If set to Auto, a USB devices with a capacity of equal or less than 2 GB will be emulated as a bootable floppy disk.	Auto Floppy Hard Disk
Onboard Graphics Controller	Enables or disables the onboard graphics controller.	Enabled Disabled
Onboard Audio Controller	Enables or disables the onboard audio controller.	Enabled Disabled
Onboard LAN Controller	Enables or disables the onboard LAN controller.	Enabled Disabled
Onboard LAN Option ROM	Enables or disables the onboard LAN option ROM function.	Enabled Disabled

Power Management Setup



Field	Description	Value
ACPI Suspend Mode	Use this item to define how your system suspends. Default value is S3 (STR), the suspend mode is suspend to RAM, i.e., the system shuts down with the exception of a refresh current to the system memory.	S3 (STR) S1 (POS)
Deep Power Off Mode	Enables or disables compliance to the Energy-using Products Lot 6 Directives (EuP Lot 6).	Enabled Disabled
Power On by RTC Alarm	Enables or disables the system to wake up from a power-saving mode when an RTC alarm occurs.	Enabled Disabled
Power On by PCIE Devices	Enables or disables the system to wake up from a power-saving mode when an event occurs on an installed PCI Express device.	Enabled Disabled
Power On by PCI Devices	Enables or disables the system to wake up from a power-saving mode when an event occurs on an installed PCI device.	Enabled Disabled
Power On by Modem Ring	Enables or disables the system to wake up from a power-saving mode when a modem signal is received. network message	Enabled Disabled
Power On by Onboard LAN	Enables or disables the system to wake up from a power-saving mode when the onboard LAN controller received a network message.	Enabled Disabled
Wake Up by PS/2 KB/Mouse	Enables or disables the system to wake up from a power-saving mode when a PS/2 keyboard or mouse is used.	Enabled Disabled
Wake Up by USB KB/Mouse	Enables or disables the system to wake up from a power-saving mode when a USB keyboard or mouse is used.	Enabled Disabled
Restore On AC Power Loss	Select the power state when an AC power loss occurs. <ul style="list-style-type: none"> Off - The computer remains off until the power button is pressed. Last State - The computer reverts to the last power state before the power loss occurred. On - The computer switches back on after the AC power loss. 	Power Off Power On Last State

PC Health Status

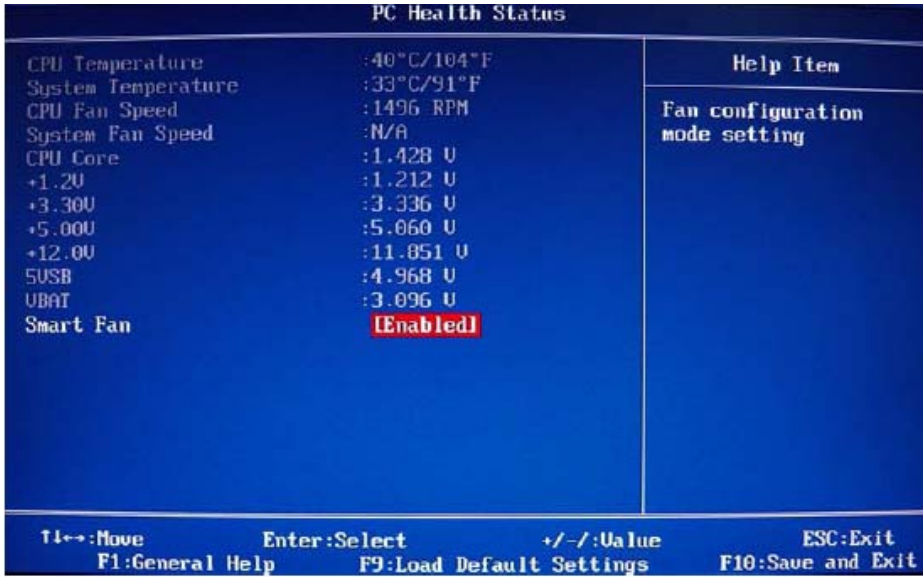

Field	Description	Value
CPU Temperature System Temperature CPU Fan Speed System Fan Speed CPU Core +1.1V +3.30V +5.00V +12.0V 5VSB VBAT	These items lets you monitor the parameters for critical voltages, temperatures and fan speeds.	
Smart Fan	When enabled, fan speed will speed up or slow down depending on the system temperature.	Enabled Disabled

Frequency/Voltage Control

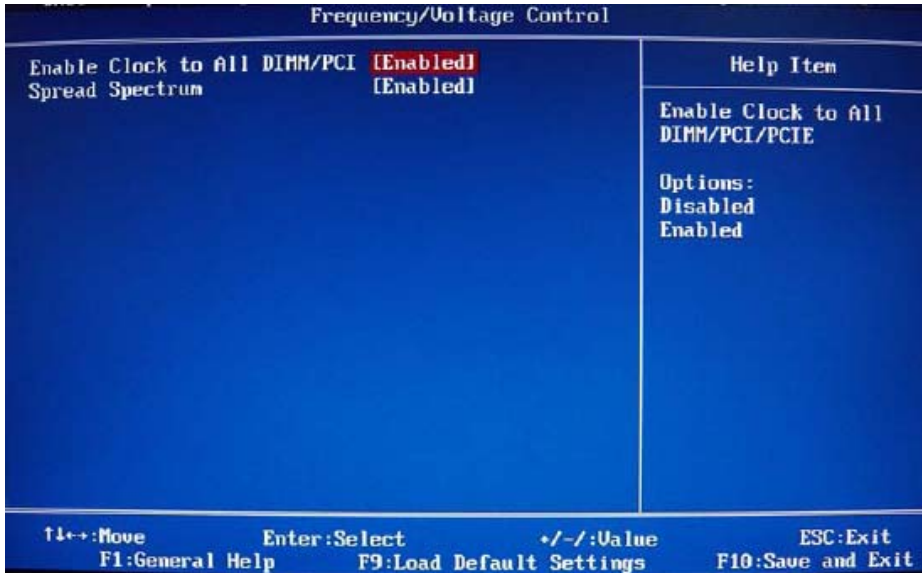

Field	Description	Value
Enable Clock to All DIMM/PCI	When enabled, clock signals will be sent to the PCI and memory slots regardless of whether the slot is occupied or not.	Enabled Disabled
Spread Spectrum	When the mainboard's clock generator pulses, the extreme values of the pulses creates EMI (electromagnetic interference). Set this field to Enabled to reduce this EMI level. This reduces interference problems with other electronics in the area. Note: Remember to disable the Spread Spectrum feature if you are overclocking. A slight jitter can introduce a temporary boost in clock speed causing the overclocked processor to lock up.	Enabled Disabled

BIOS Security Features

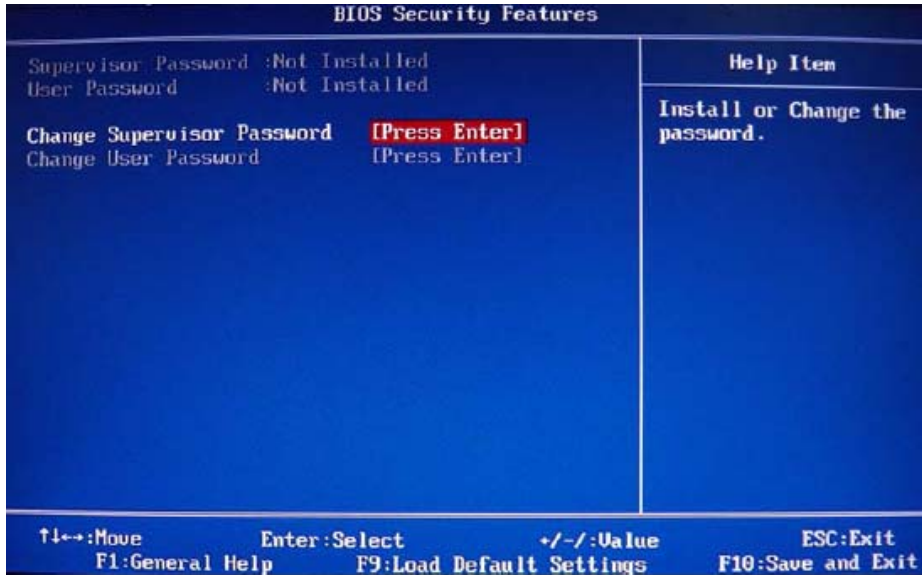

Field	Description	Value
Supervisor Password	Displays the supervisor password status. When set to Installed, this password will allow the user to access and change all settings in the Setup Utility.	Installed Not Installed
User Password	Displays the user password status. Only the following menus will be accessible when this password is set as Installed: <ul style="list-style-type: none"> • System Date and System Time • Exit Without Saving 	
Change Supervisor Password	Press Enter to change the supervisor password.	
Change User Password	Press Enter to change the user password.	

Note the following before you define a system password:

- The maximum length of password contains 8 alphanumeric characters. The following keys are valid:
 - A-Z, a-z (case-insensitive)
 - 0-9
 - ` - + [] \ ; ' , . / ,
 - Special keypad characters: 0-9 / * - +
- When you are prompted to enter a password, you have three tries before the system halts. Do not forget your password. If you forget your password, you may have to return your computer to your dealer to reset it.

To set a system password:

NOTE You need to set a supervisor password first before setting the user password.

1. Select Change Supervisor Password or Change User Password, then press **Enter**.

The password box appears.

2. Type a password then press **Enter**.

IMPORTANT Be very careful when typing your password because the characters do not appear on the screen. Only shaded blocks representing each typed character are visible.

3. Retype the password to verify the first entry, then press **Enter**.

You will be prompted to save the new password.

4. Press **Enter**.
5. Press **F10** to save the password and close the Setup Utility.

To change a system password:

1. Select Change Supervisor Password or Change User Password, then press **Enter**.

The password box appears.

2. Type the original password, then press **Enter**.
3. Type a new password, then press **Enter**.
4. Retype the new password to verify the first entry, then press **Enter**.

You will be prompted to save the new password.

5. Press **Enter**.
6. Press **F10** to save the password and close the Setup Utility.

To remove a system password:

NOTE When the supervisor password is removed, the user password will also be remove.

1. Select Change Supervisor Password or Change User Password, then press **Enter**.

The password box appears.

2. Type the original password, then press **Enter**.
3. Press **Enter** twice without entering anything in the new and confirm password fields.

You will be prompted to confirm the password removal.

4. Press **Enter**.
5. Press **F10** to save the changes you made and close the Setup Utility.

Load Default Settings

Execute this menu to load the factory-default settings for all Setup parameters. Keyboard shortcut: F9

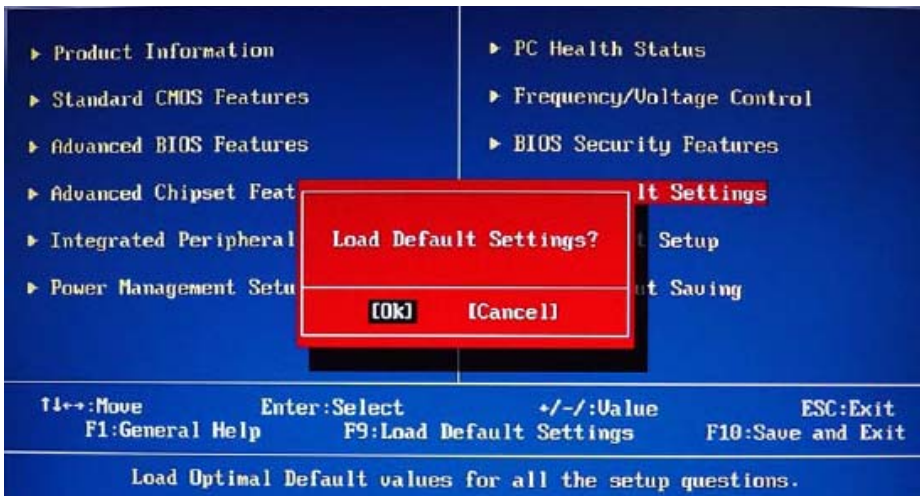

Perform the steps below to load the system default settings:

1. Select Load Default Settings, then press **Enter**.
You will be prompted to load the system defaults.
2. Select **OK**, then press **Enter**.
3. Press **F10** to save the changes you made and close the Setup Utility.

Save & Exit Setup

Execute this menu to save the changes made and closes the Setup Utility. Keyboard shortcut: F10

Exit Without Saving

Execute this menu to closes the Setup Utility without making any changes.

System Disassembly

This chapter provides step-by-step instructions on how to disassemble the computer for maintenance and troubleshooting purposes.

Disassembly Tools

In performing the disassembly process, you will need the following tools:

- Wrist-grounding strap and conductive mat for preventing electrostatic discharge
- Philips screwdriver
- Hex screwdriver
- Flat screwdriver

- NOTES**
- To reinstall the system components and assemble the unit, perform the disassembly procedures in reverse.
 - The screws for the different components vary in size. During the disassembly process, group the screws with their corresponding components to avoid mismatches when putting back the components.

Pre-disassembly Procedure

Before proceeding with the disassembly procedure, perform the steps listed below:

1. Make sure that the optical disc drive and the card reader slot are empty.
2. Turn off the power to the computer and all peripherals.
3. Unplug the power cord from the computer.
4. Unplug the network cable and all connected peripheral devices from the computer.
5. Place the computer on a flat, steady surface with the rear cover facing upward.

Disassembly Procedures

Removing the Computer Stand

1. Perform the “Pre-disassembly Procedure” on page 25.
2. Use a flat screwdriver to pry off the plastic shell covering the computer stand screws.



3. Remove the screws securing the computer stand.



Quantity	Color	Torque	Part Number
6	Black	4.0–4.5 kgf-cm	86.00N85.266

4. Remove the computer stand.



Removing the I/O Cable Cover

1. Use a flat screwdriver to pry off the I/O cable cover.



2. Remove the I/O cable cover



Removing the Rubber Feet

1. Perform the "Pre-disassembly Procedure" on page 25.
2. Use a flat screwdriver to pry off the rubber feet from the computer base.



Removing the Rear Cover

1. Remove the computer stand by following the procedure described on page 26.
2. Remove the I/O cable cover and the rubber feet by following the procedures described on page 27.
3. Use a flat screwdriver to carefully pry loose the rear cover from the front bezel.

The picture below shows the location of the plastic snaps securing the rear cover to the front bezel.



4. Toggle the cover from left to right to loosen its hold on the front bezel, then detach the rear cover.



Removing the I/O Cable Plate

1. Remove the rear cover by following the procedure described in the previous section.
2. Push the latch to disengage the I/O cable plate from the main chassis.

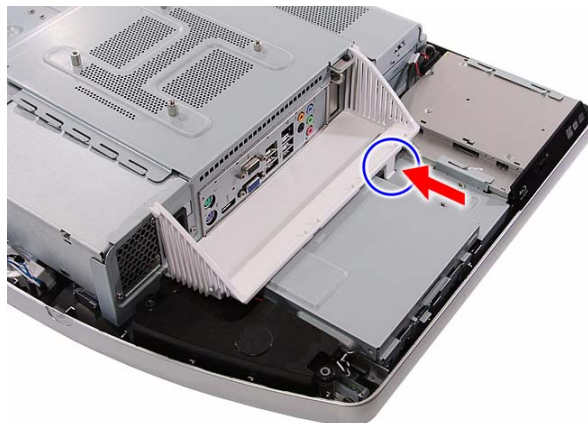

3. Remove the I/O cable plate.

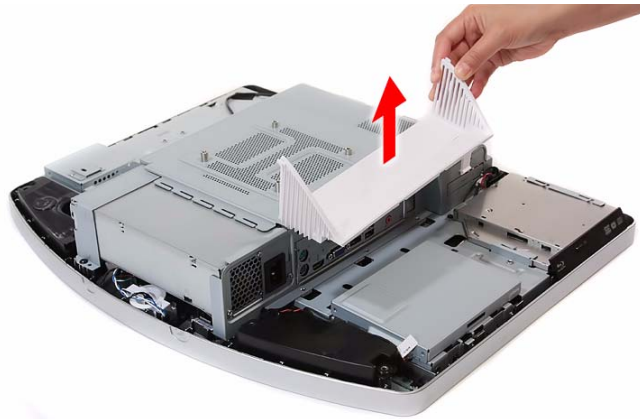

Removing the Optical Disc Drive

1. Remove the rear cover by following the procedure described on page 28.
2. Remove the screw securing the ODD.



Quantity	Color	Torque	Part Number
1	Black	4.0–4.5 kgf-cm	86.00B75.240

3. Slide the ODD outward, then disconnect the ODD SATA cable from the drive.

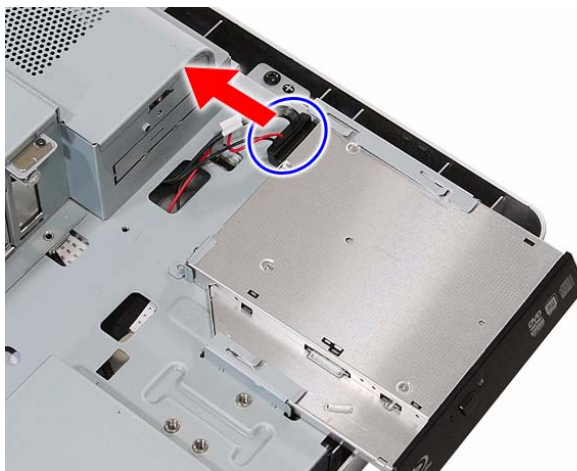

4. Remove the ODD from the main chassis.

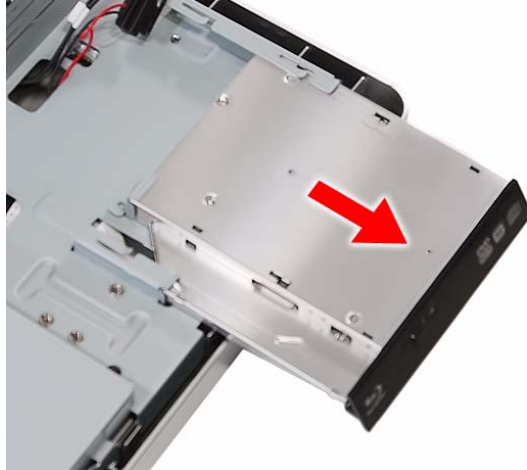

5. Remove the screw securing the ODD bracket.



Quantity	Color	Torque	Part Number
1	Silver	1.3–1.5 kgf-cm	86.7A122.4R0

6. Detach the ODD bezel from the module.



Removing the Scaler Board

1. Remove the rear cover by following the procedure described on page 28.
2. Remove the screw securing the scaler board cover.



Quantity	Color	Torque	Part Number
1	Black	4.0–4.5 kgf-cm	86.00B75.240

3. Slide the scaler board cover towards the speaker area to disengage the cover tabs from the main chassis, then remove the scaler board cover.



4. Disconnect all the cables from the scaler board.

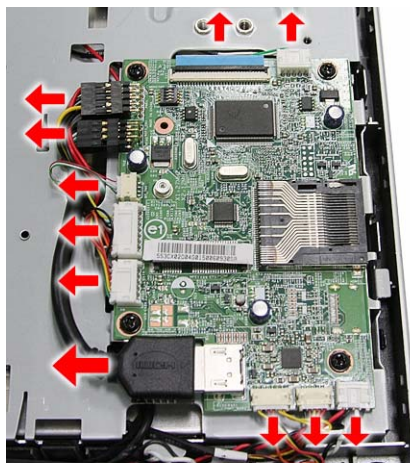

5. Remove the screws securing the scaler board.

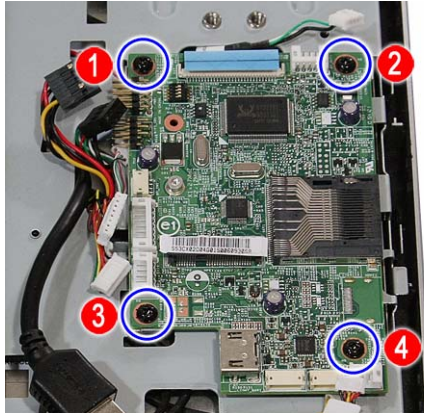

Quantity	Color	Torque	Part Number
4	Black	4.0 kgf-cm	86.00B75.240

6. Remove the scaler board.

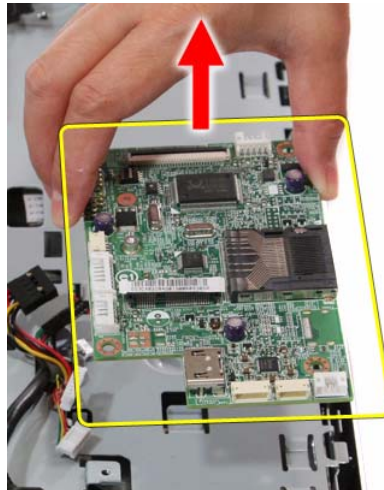

A circuit board that is $>10 \text{ cm}^2$ has been highlighted with a yellow rectangle as shown in the above image. Follow local regulations for disposing this type of circuit board.

Removing the USB/Audio Board

1. Remove the rear cover by following the procedure described on page 28.
2. Remove the screw securing the USB/audio board cover.



Quantity	Color	Torque	Part Number
1	Black	4.0–4.5 kgf-cm	86.00B75.240

3. Slide the USB/audio board cover outward to disengage the cover tabs from the main chassis, then remove the USB/audio board cover.



4. Disconnect the two cables from the USB/audio board.



5. Remove the screws securing the USB/audio board.

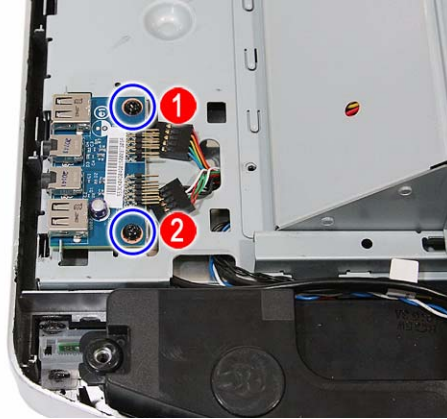

Quantity	Color	Torque	Part Number
2	Black	4.0 kgf-cm	86.00B75.240

6. Slide the USB/audio board out of its tabs.

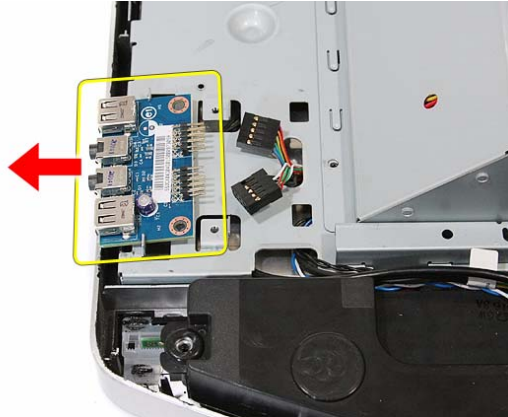

A circuit board that is $>10 \text{ cm}^2$ has been highlighted with a yellow rectangle as shown in the above image. Follow local regulations for disposing this type of circuit board.

Removing the Wall Mount Plate

1. Remove the rear cover by following the procedure described on page 28.
2. Remove the screws securing the wall mount plate.

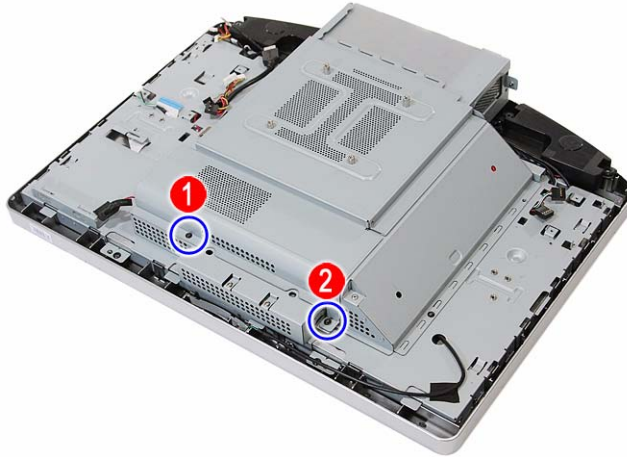

Quantity	Color	Torque	Part Number
2	Black	4.0–4.5 kgf-cm	86.00B75.240

3. Slide the wall mount plate towards the HDD area to disengage the plate tabs from the main chassis, then remove the wall mount plate.



Removing the TV Tuner Card

1. Remove the wall mount plate by following the procedure described in the previous section.
2. Disconnect the TV tuner card cable.

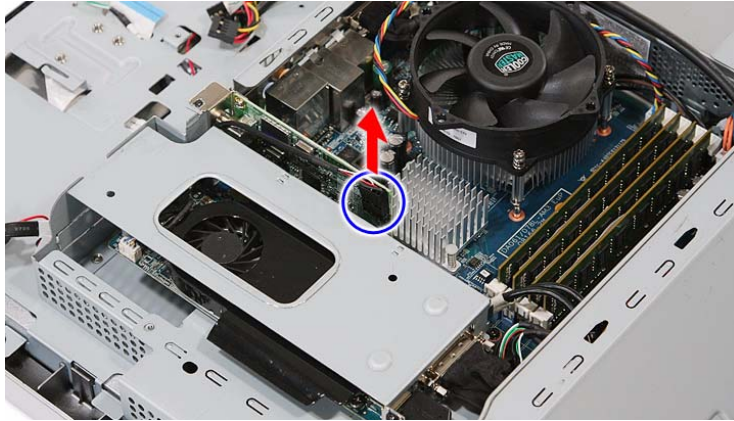

3. Remove the screw securing the TV tuner card bracket.

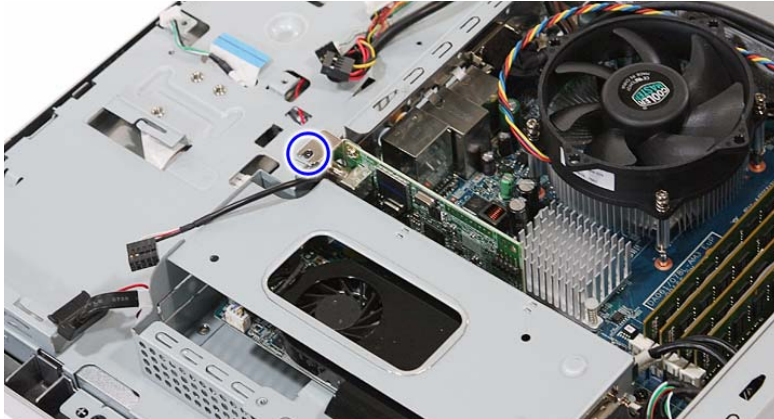

Quantity	Color	Torque	Part Number
1	Black	4.0–4.5 kgf-cm	86.00B75.240

4. Disconnect TV tuner card from its expansion slot.

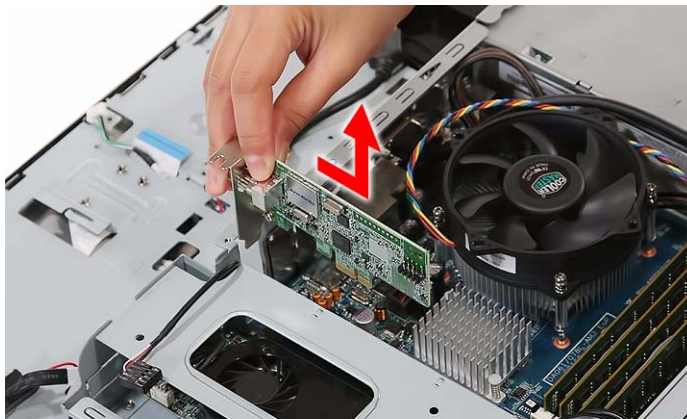

Removing the Graphics Card

1. Remove the wall mount plate by following the procedure described on page 35.
2. Remove the screw securing the inverter board cover.



Quantity	Color	Torque	Part Number
1	Black	4.0–4.5 kgf-cm	86.00B75.240

3. Remove the inverter board cover.



4. Disconnect the HDMI cable from the graphics card.

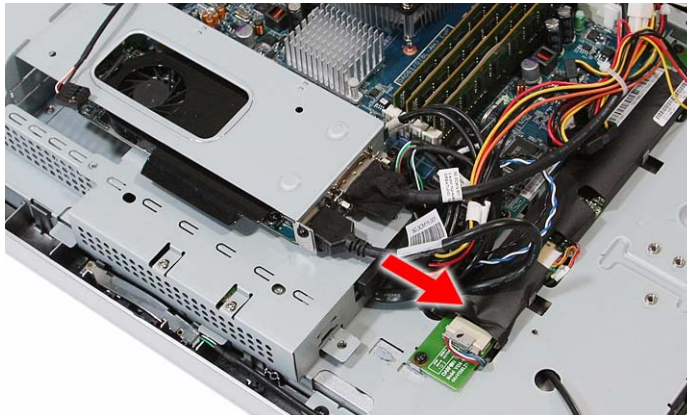

5. Remove the hex screws securing the serial-to-DVI cable.

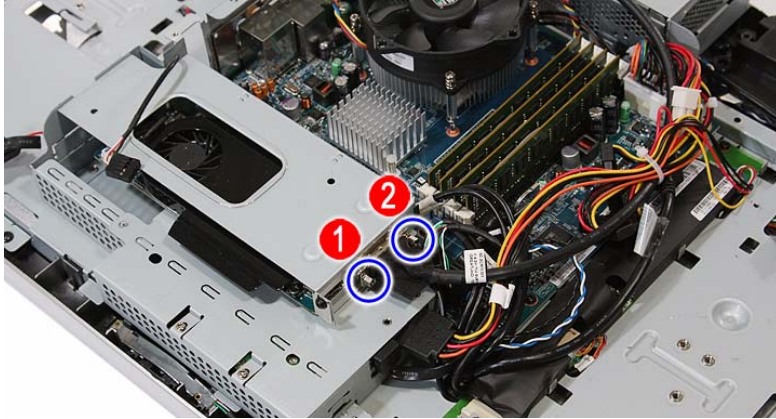

Quantity	Color	Torque	Part Number
2	Silver	4.5 kgf-cm	86.80536.7R2

6. Disconnect the serial-to-DVI cable from the graphics card.



7. Disconnect the graphics card assembly from its expansion slot.

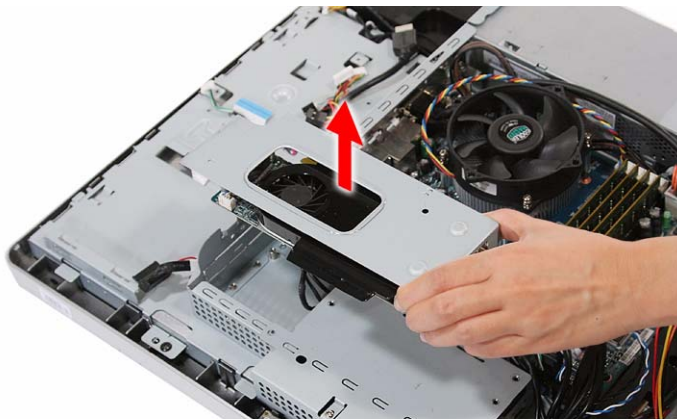

8. Remove the screw securing the graphics card bracket.



Quantity	Color	Torque	Part Number
1	Black	4.0–4.5 kgf-cm	86.00B75.240

9. Disconnect the graphics card from its riser board.



A circuit board that is >10 cm² has been highlighted with a yellow rectangle as shown in the above image. Follow local regulations for disposing this type of circuit board.

10. Remove the screws securing the graphics card riser board.

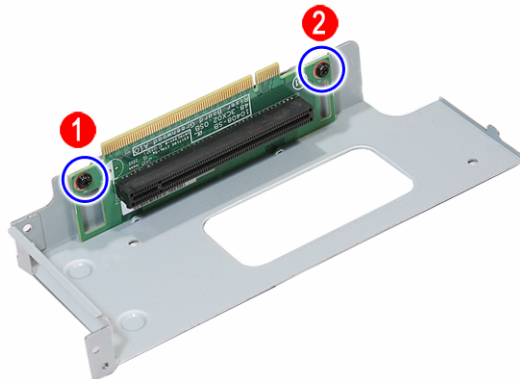

Quantity	Color	Torque	Part Number
2	Black	4.0–4.5 kgf-cm	86.00B75.240

11. Remove the graphics card riser board from its bracket.

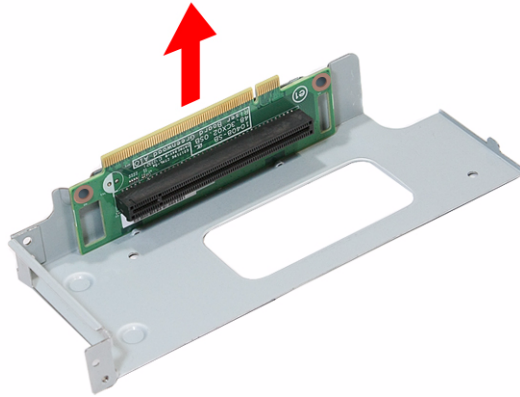

Removing the Hard Disk Drive

1. Remove the graphics card by following the procedure described on page 37.
2. Disconnect the power and SATA cables from the hard drive.



3. Slide the HDD assembly outward to disengage the assembly from the main chassis, then remove the HDD assembly.

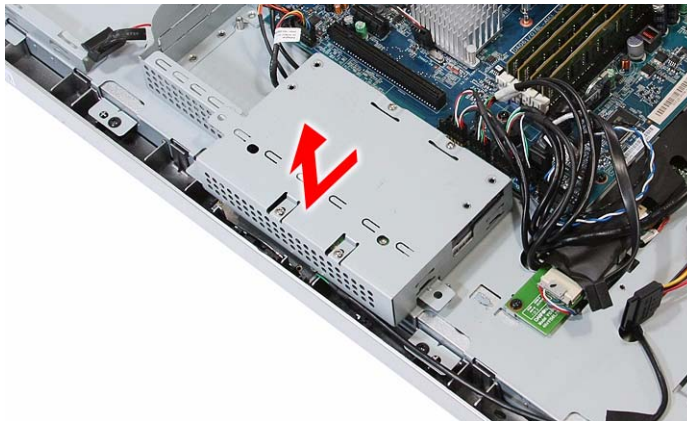

4. Disconnect the HDD SATA cable from the mainboard.



5. Remove the screws securing the hard drive to its cage.

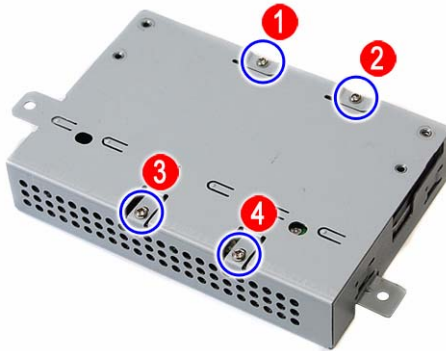

Quantity	Color	Torque	Part Number
4	Silver	4.0–4.5 kgf-cm	86.00J44.C60

6. Use a small metal screwdriver to push the hard drive out of its cage (a), then pull out the drive out (b).

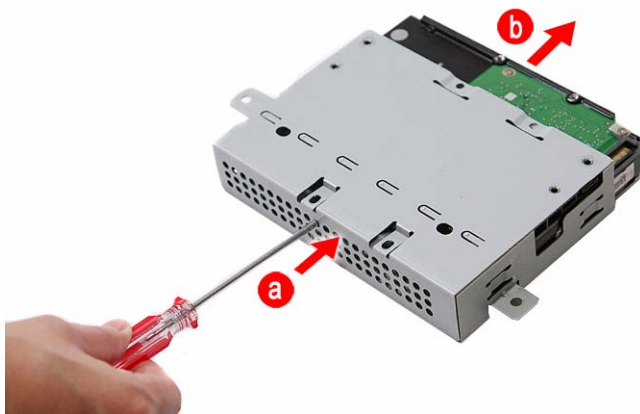

Removing the Inverter Board

1. Remove the wall mount plate by following the procedure described on page 35.
2. Remove the inverter board cover by following steps 2 and 3 on page 37.
3. Disconnect all cables from the inverter board.

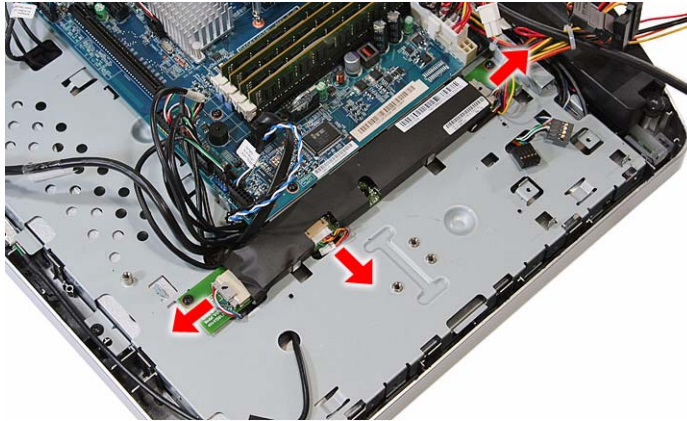

4. Remove the screws securing the inverter board.

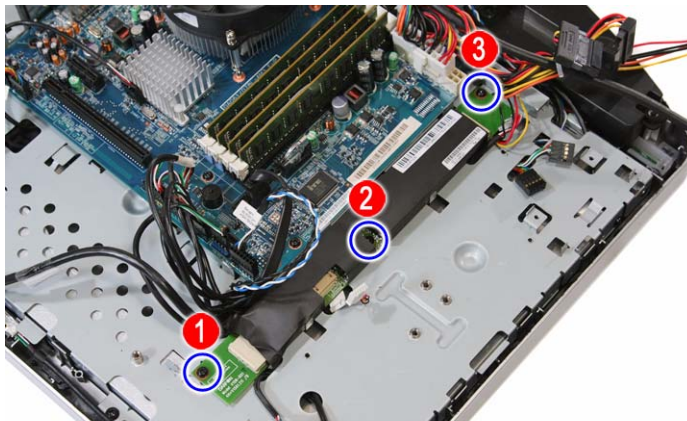

Quantity	Color	Torque	Part Number
3	Black	4.0 kgf-cm	86.00B75.240

5. Remove the inverter board.

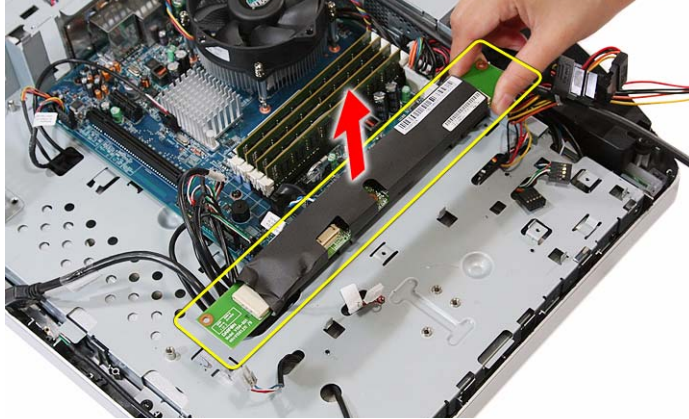

A circuit board that is $>10 \text{ cm}^2$ has been highlighted with a yellow rectangle as shown in the above image. Follow local regulations for disposing this type of circuit board.

Removing the Heat Sink Fan (HSF) Assembly

1. Remove the wall mount plate by following the procedure described on page 35.
2. Disconnect the HSF cable from its mainboard connector.

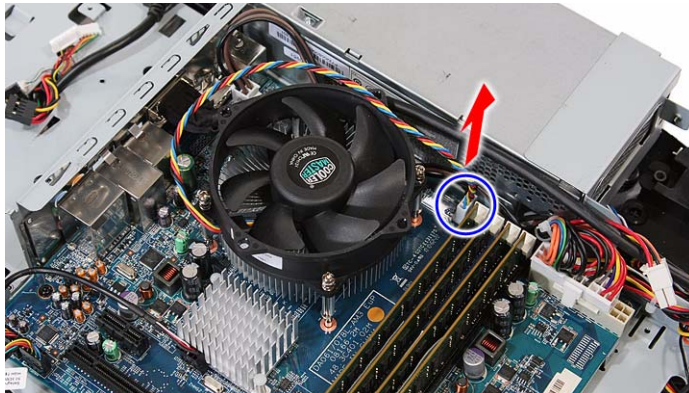

- Loosen the HSF's spring-loaded screws in a diagonally opposite pattern (an "X" pattern).

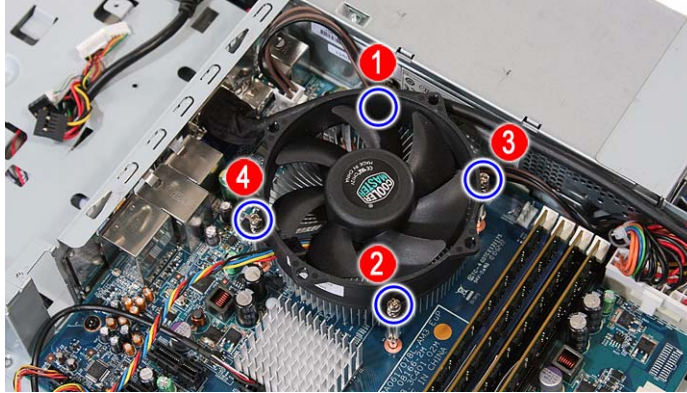

Quantity	Color	Torque	Part Number
4	Silver	4.0–4.5 kgf-cm	–

- Remove the HSF assembly.

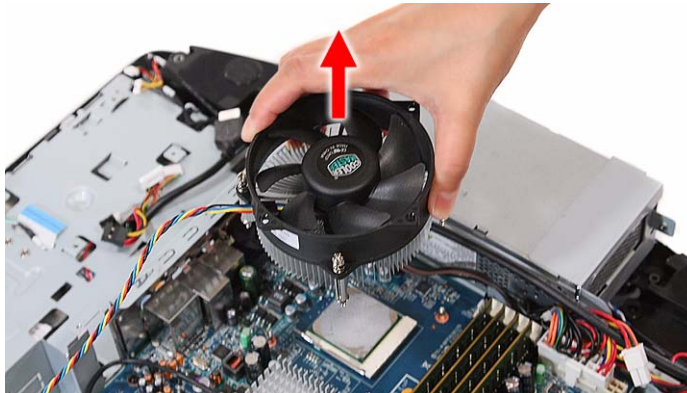

Removing the Processor

- Remove the HSF assembly by following the procedure described on the previous section.
- Press down the socket lever, then move it left to release.

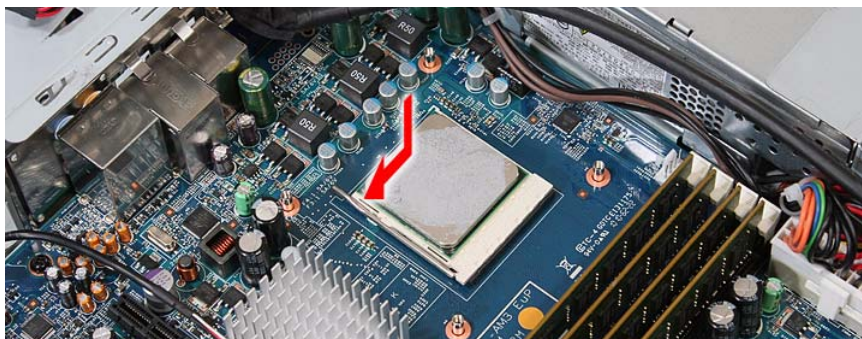

3. Rotate the socket lever to the open position.

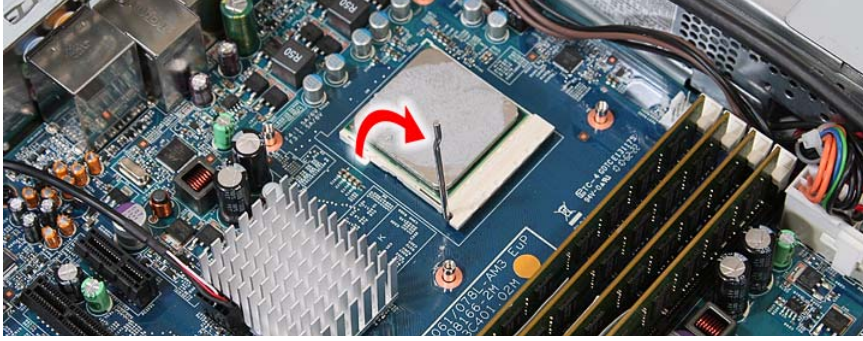

4. Gently lift the processor out of its socket.

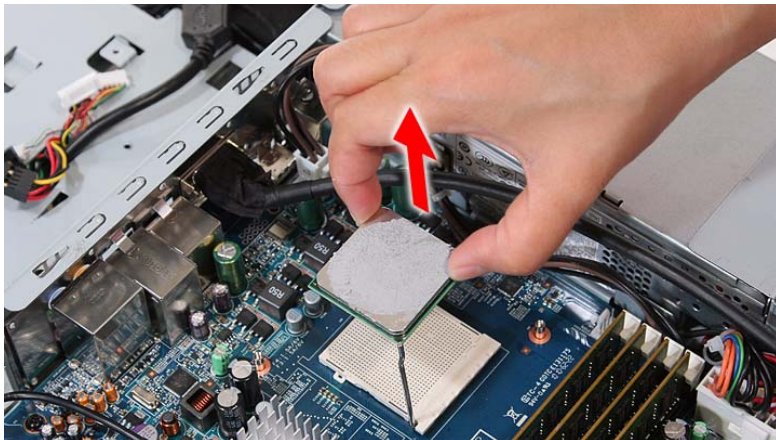

CAUTION DO NOT lay the processor on its base to avoid bending or damaging the pins underneath it.

IMPORTANT When installing a processor:

- Note the golden arrow on the corner to make sure the processor is properly oriented over the socket.
- Moisten a soft cloth with isopropyl alcohol and clean the processor die to remove any thermal grease residue. Wipe the die surface several times to make sure that no particles or dust contaminants are evident. Allow the alcohol to evaporate before continuing. Apply just enough thermal grease to evenly coat the surface of the processor die.

Removing the Memory Modules

1. Remove the wall mount plate by following the procedure described on page 35.
2. Open the holding clips securing the memory modules (a), then remove the memory modules from the DIMM slots (b).

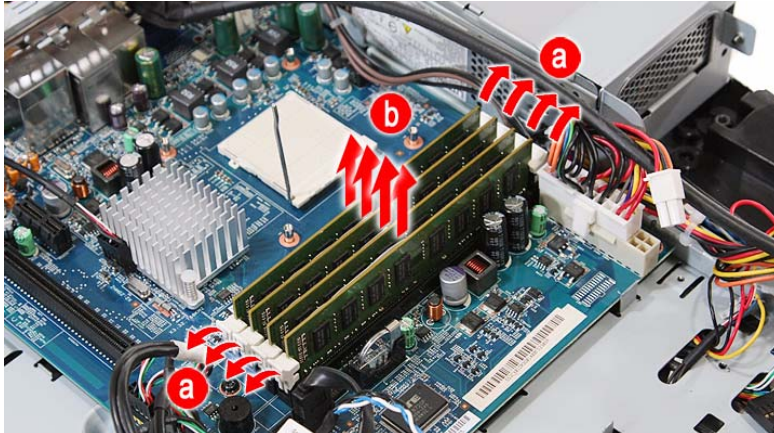

Removing the RTC Battery

1. Remove the wall mount plate by following the procedure described on page 35.
2. Detach the socket latch from the RTC battery.

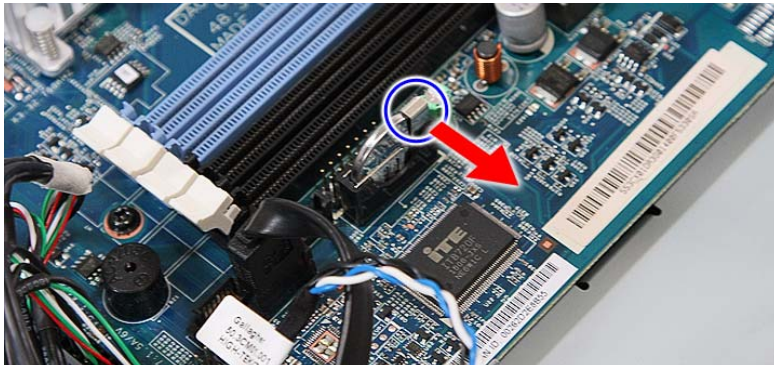

3. Remove the RTC battery from its socket.

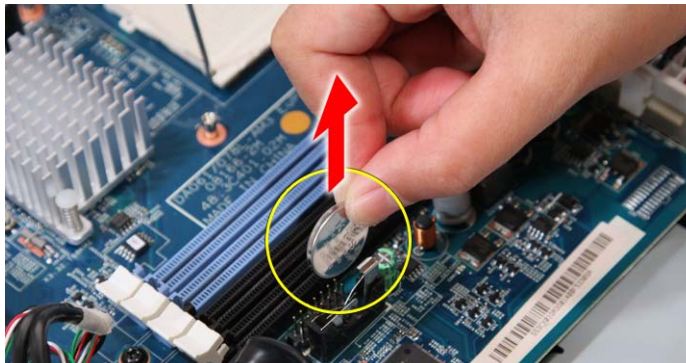

The RTC battery has been highlighted with a yellow circle in the above image. Detach the RTC battery and follow local regulations for disposing it.

Removing the Mainboard

1. Remove the TV tuner card by following the procedure described on page 36.
2. Remove the graphics card by following the procedure described on page 37
3. Remove the hard drive by following the procedure described on page 40.
4. Remove the HSF assembly by following the procedure described on page 43.
5. Remove the processor by following the procedure described on page 44.
6. Remove the memory modules by following the procedure described on page 46.
7. Remove the RTC battery by following the procedure described on the previous section.
8. Remove the hex screws securing the serial-to-DVI cable.



Quantity	Color	Torque	Part Number
2	Silver	4.5 kgf-cm	86.80536.7R2

9. Detach the serial-to-DVI cable from the I/O port panel bracket.



10. Disconnect all cables from the upper edge area of the mainboard.

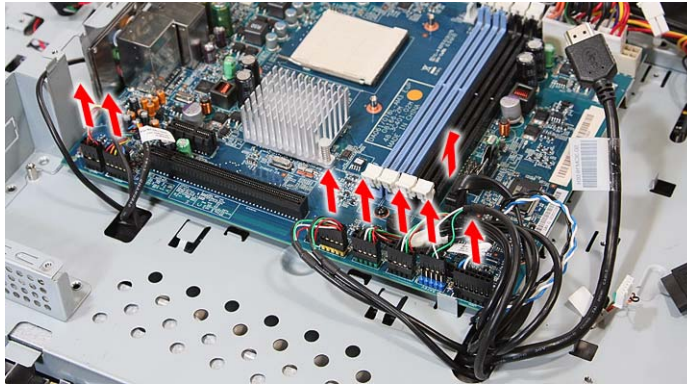

11. Disconnect the 4-pin and 20-pin ATX power cables from their mainboard connectors.

- a. Press the top portion of the cable's retaining latch
- b. Pull the cable straight up from its connector.

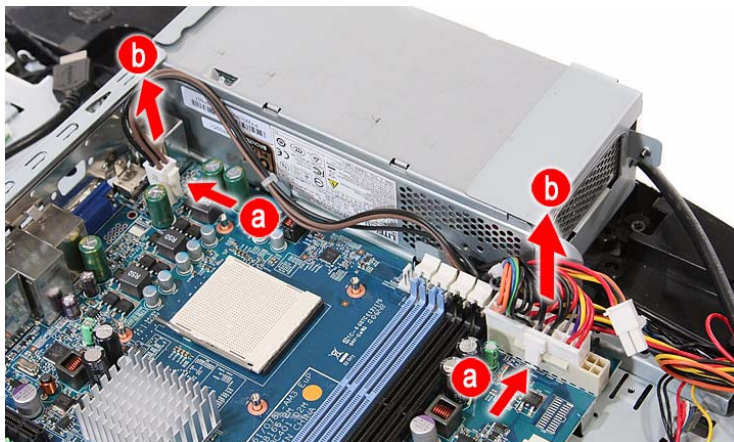

12. Remove the screws securing the mainboard.

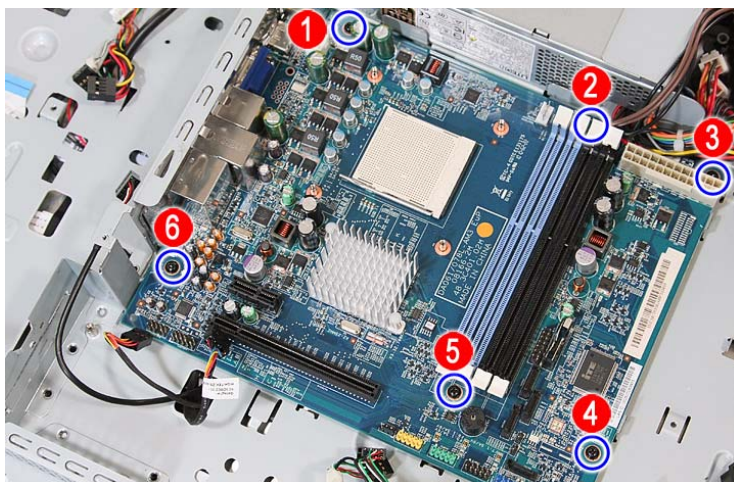

Quantity	Color	Torque	Part Number
6	Black	4.0 kgf-cm	86.00B75.240

13. Remove the mainboard.

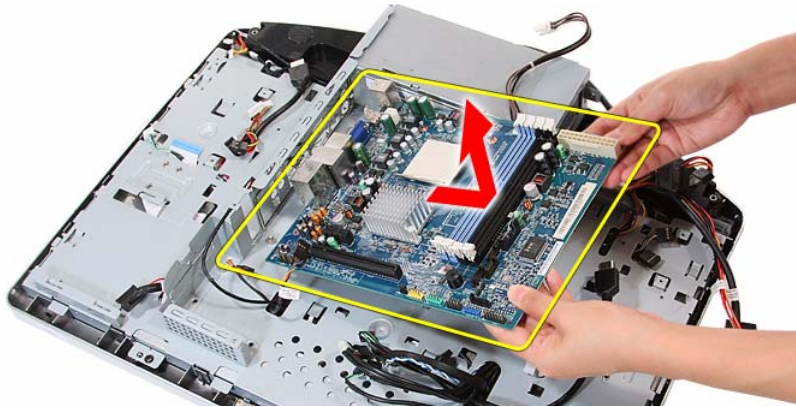

A circuit board that is $>10\text{ cm}^2$ has been highlighted with a yellow rectangle as shown in the above image. Follow local regulations for disposing this type of circuit board.

Removing the Power Supply Unit

1. Disconnect the scalar board power cable by performing steps 1–4 of the scalar board removal procedure on page 31.
2. Disconnect the hard drive power cable by performing steps 1 and 2 of the HDD removal procedure on page 40.
3. Disconnect the ATX power cables by performing step 11 of the mainboard removal procedure on page 48.
4. Remove the screws securing the PSU to the main chassis.

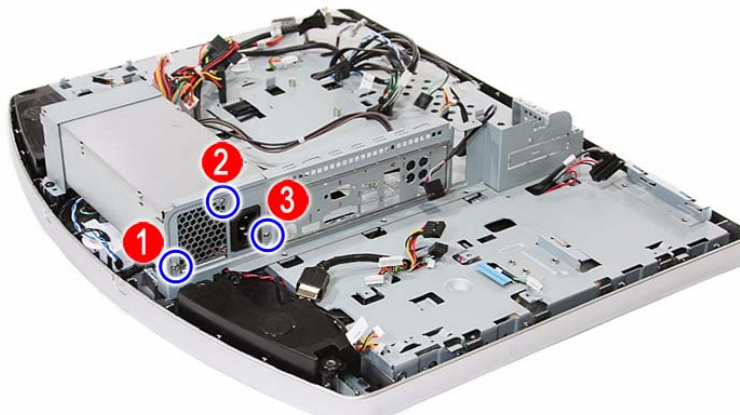

Quantity	Color	Torque	Part Number
3	Silver	4.0 kgf-cm	86.00J44.C60

- Remove the screws securing the PSU bracket.

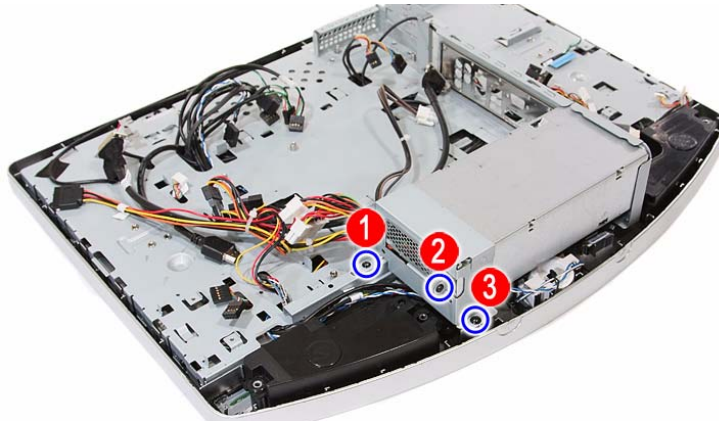

Quantity	Color	Torque	Part Number
2 (#1-2)	Black	4.0 kgf-cm	86.00J44.C60
1 (#3)	Black	4.0 kgf-cm	86.3AR26.8R0

- Detach the PSU bracket from the power supply unit.

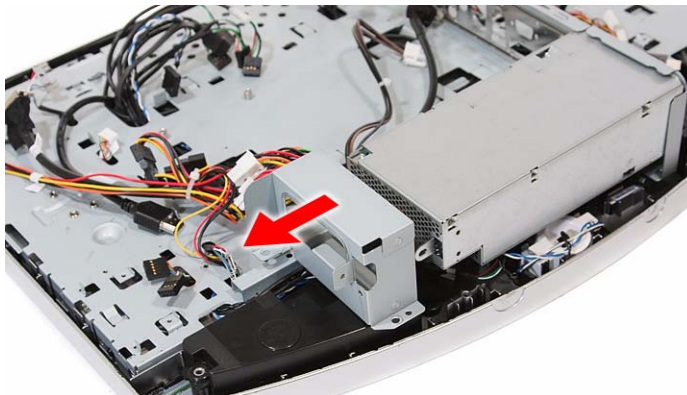

- Remove power supply unit from the front bezel and lay it down beside the system.
Some PSU connector cables are still secured underneath the main chassis so you won't be able to remove the PSU completely

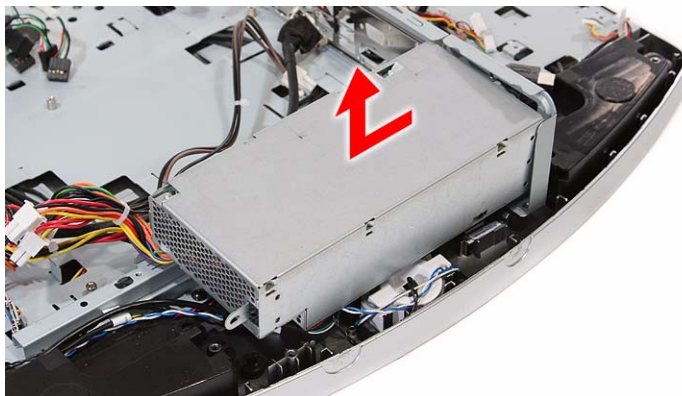

Removing the Touchscreen Control Board

1. Remove the PSU by following the procedure described on page 49.
2. Detach the black tape from the touchscreen control board cables.

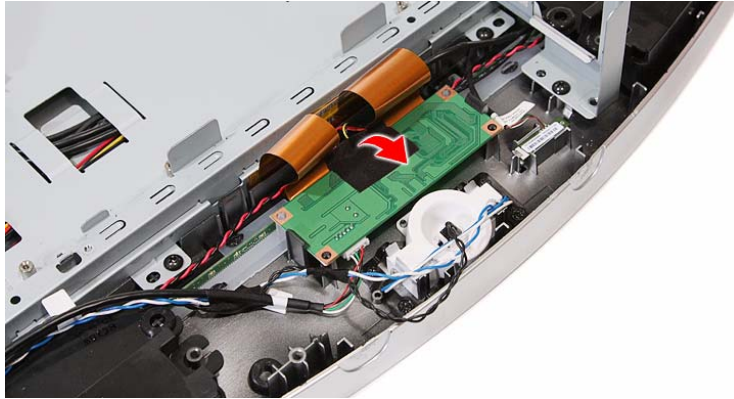

3. Push the tabs securing the touchscreen control board.

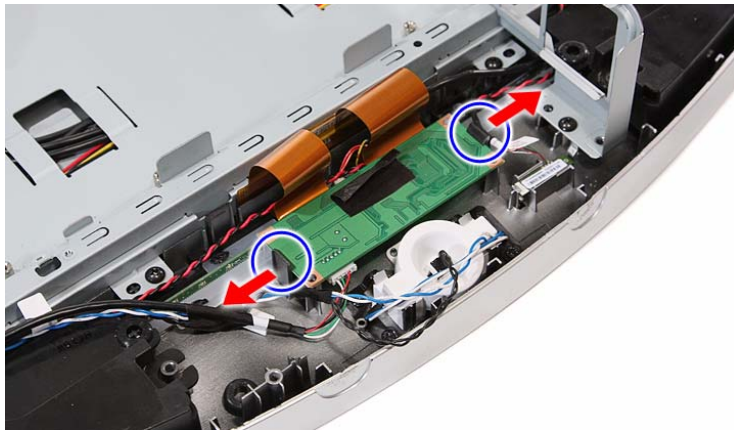

4. Remove the touchscreen control board and turn it over to expose the cable connectors underneath it.

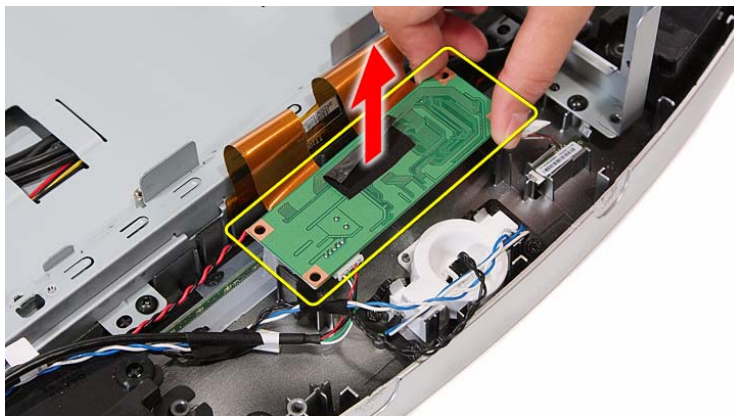

A circuit board that is $>10 \text{ cm}^2$ has been highlighted with a yellow rectangle as shown in the above image. Follow local regulations for disposing this type of circuit board.

5. Disconnect all cables from the touchscreen control board.

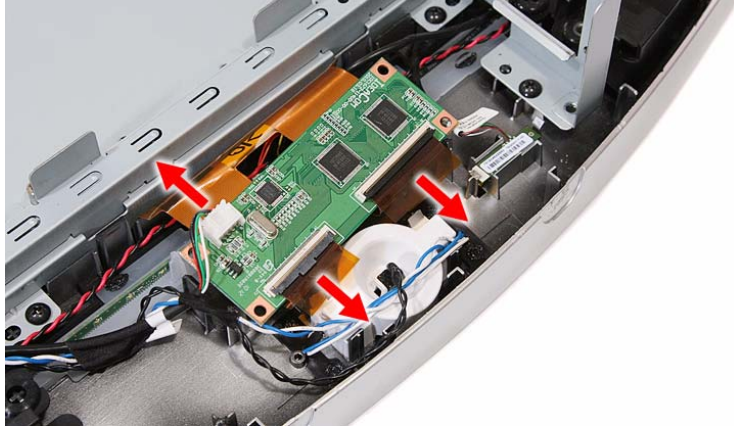

Removing the Bluetooth Module

1. Remove the PSU by following the procedure described on page 49.
2. Push the tabs securing the Bluetooth module.

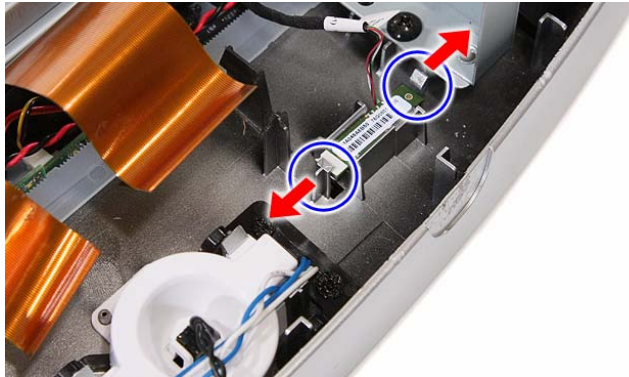

3. Remove the Bluetooth module from the front bezel and turn it over to expose the cable connector underneath it.

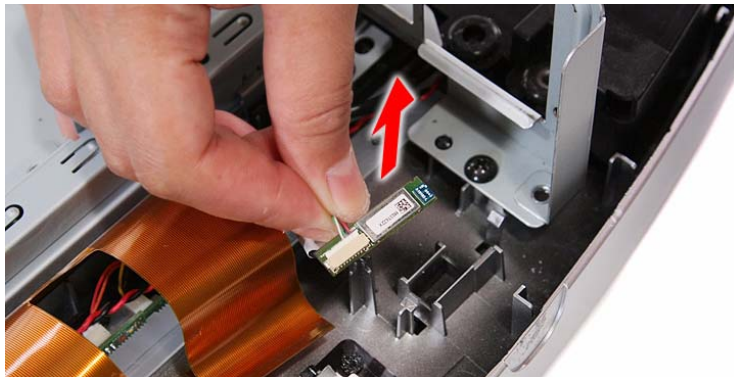

4. Disconnect the Bluetooth cable from the module.

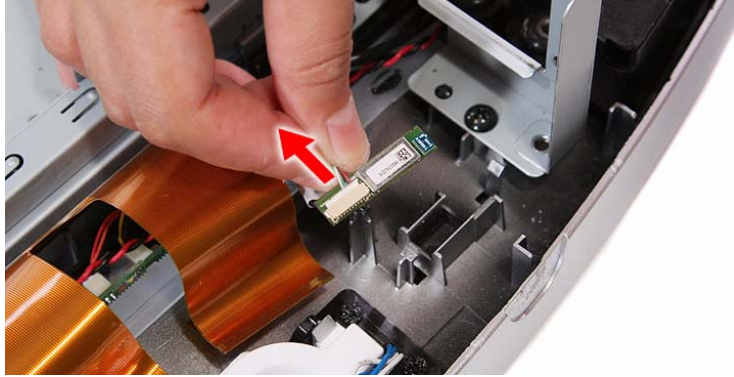

Removing the Power Button Assembly

1. Remove the PSU by following the procedure described on page 49.
2. Push the tabs securing the power button assembly.

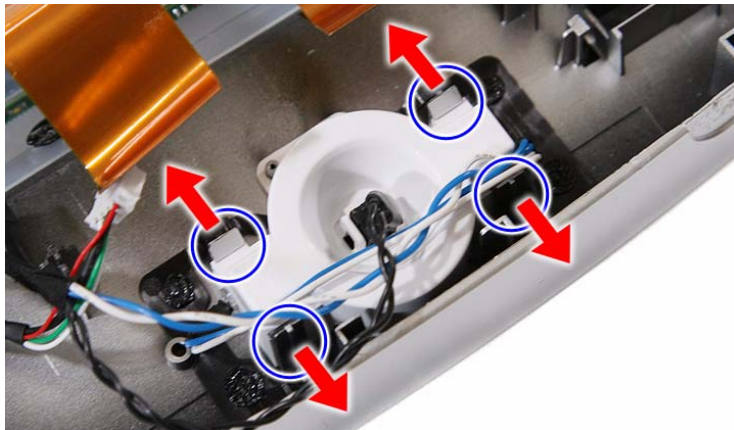

3. Remove the power button assembly from the front bezel.

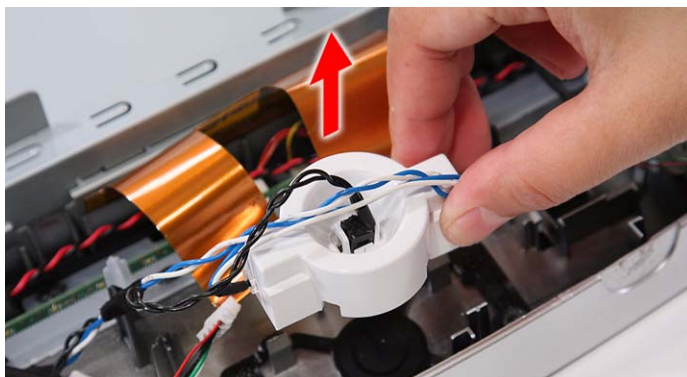

Removing the LCD Assembly

1. Remove the I/O cable plate by following the procedure described on page 28.
2. Remove the optical drive by following the procedure described on page 29.
3. Remove the scaler board by following the procedure described on page 31
4. Remove the USB/audio board by following the procedure described on page 33.
5. Remove the mainboard by following the procedure described on page 47.
6. Remove the PSU by following the procedure described on page 49.
7. Disconnect the IR cable from the front bezel.



8. Disconnect the light bar cables from the light bars.

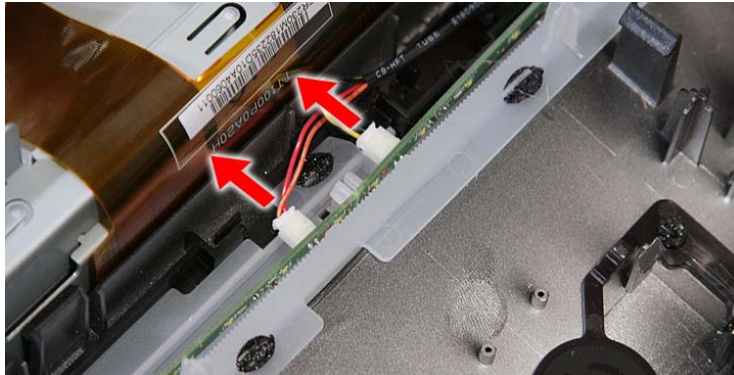

9. Remove the speakers.

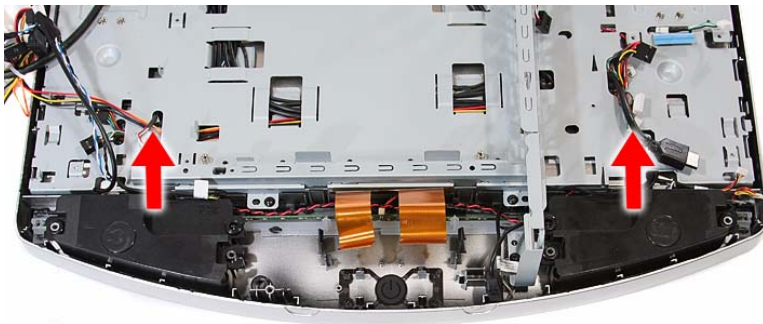

10. Disconnect the capacitive LED board cable.

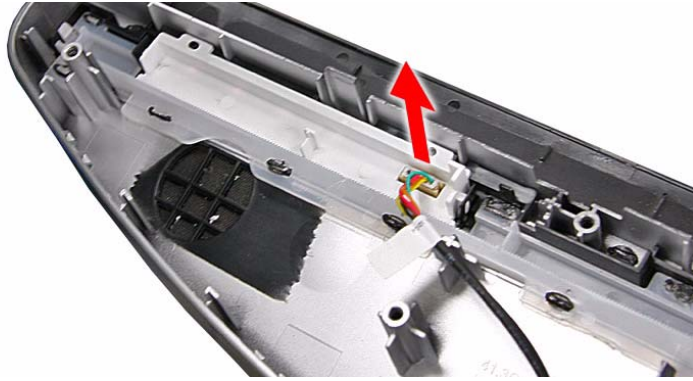

11. Disconnect the webcam cable.



12. Remove the screws securing the main chassis.

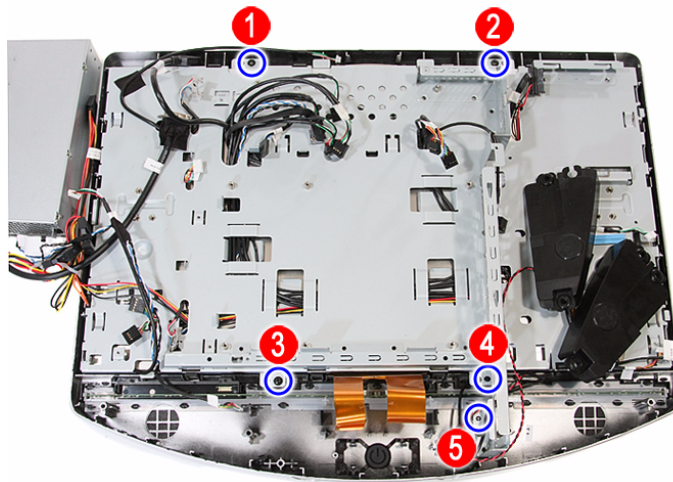

Quantity	Color	Torque	Part Number
5	Black	4.0 kgf-cm	86.3AR26.8R0

13. Push back the plastic snaps securing the LCD assembly to the front bezel.

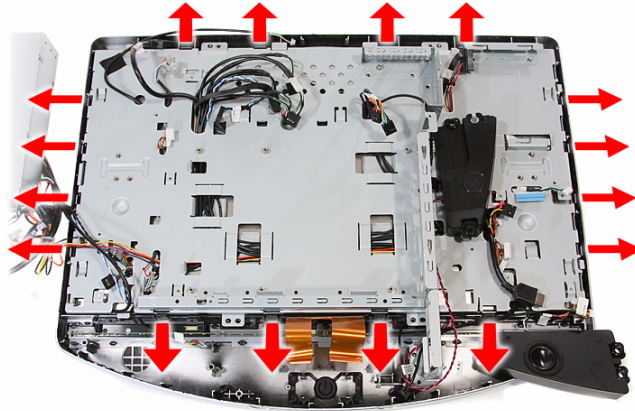

14. Detach the LCD assembly from the front bezel.

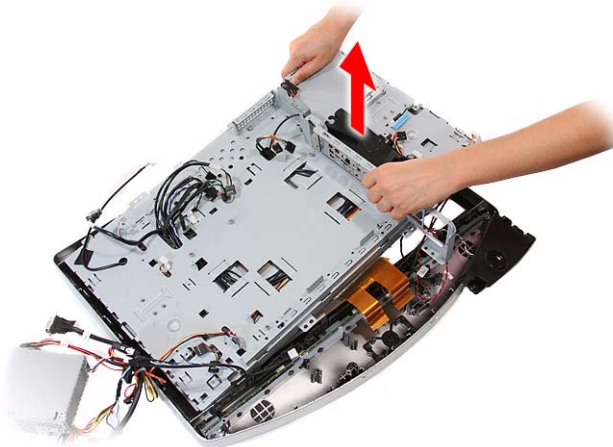

Removing the Main Chassis

1. Remove the LCD assembly by following the procedure described on page 54.
2. Remove the screws securing the main chassis to the LCD module.

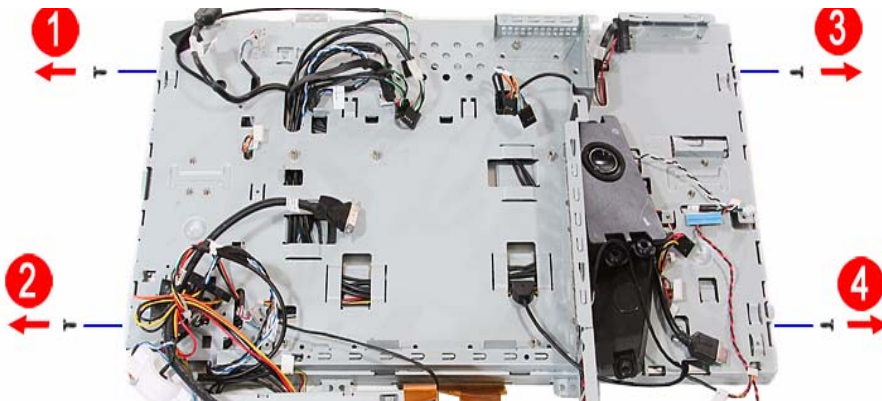

Quantity	Color	Torque	Part Number
4	Black	4.0 kgf-cm	86.00B75.240

3. Remove the main chassis from the LCD module and lay it down beside the LCD module.

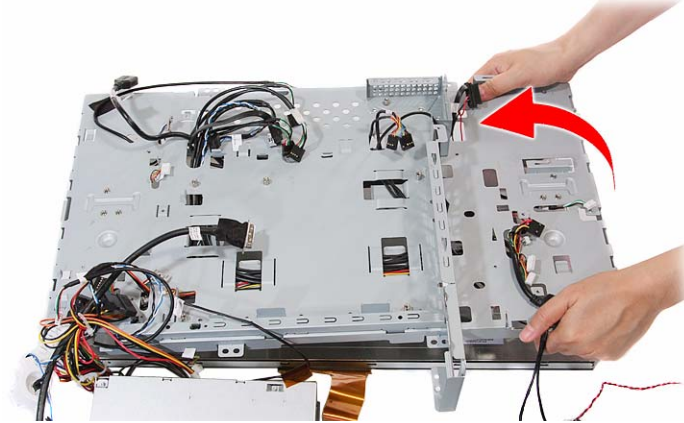

4. Release the inverter cables from the main chassis.

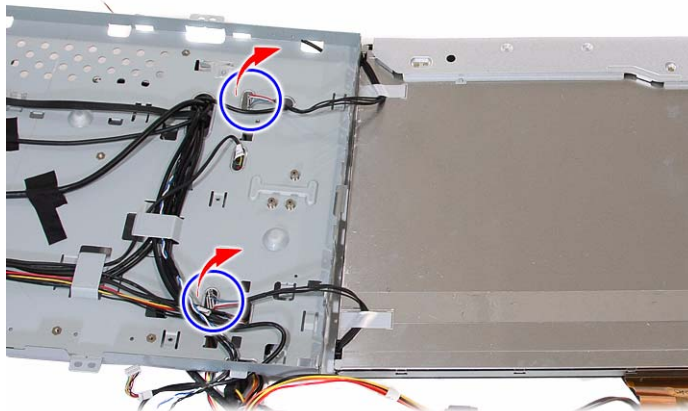

5. Remove the tapes securing the system cables, then release the cables from their main chassis latches.

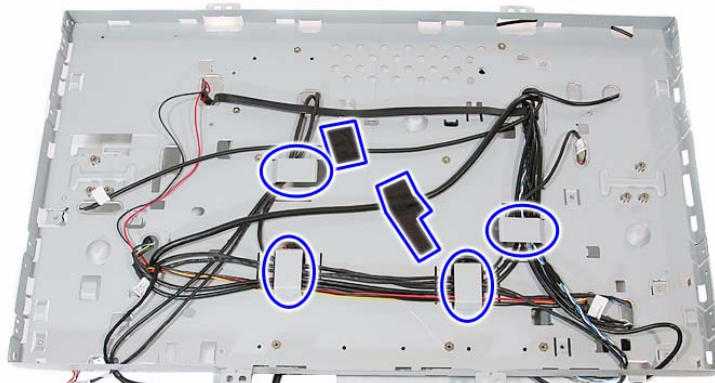

Removing the LCD Cable

1. Remove the main chassis by following the procedure described on page 56.
2. Remove the tapes securing the LCD cable (a), then disconnect the cable from the LCD board (b).

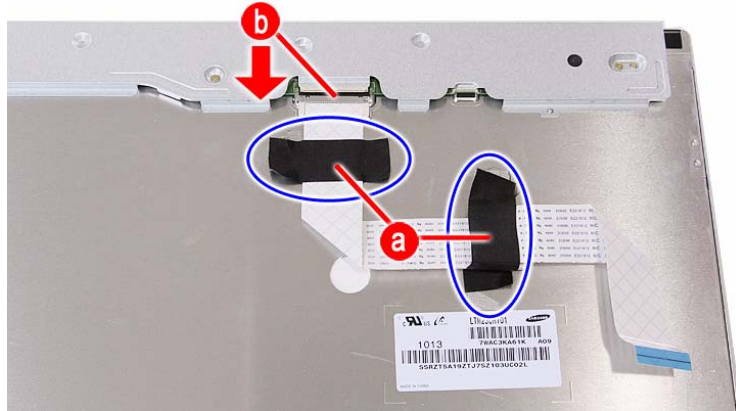

Removing the LCD Board Cover

1. Remove the main chassis by following the procedure described on page 56.
2. Remove the screws securing the LCD board cover.

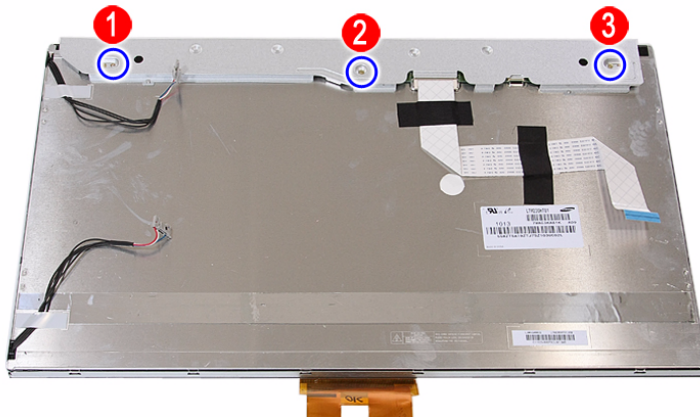

Quantity	Color	Torque	Part Number
3	Silver	—	—

3. Remove the LCD board cover.

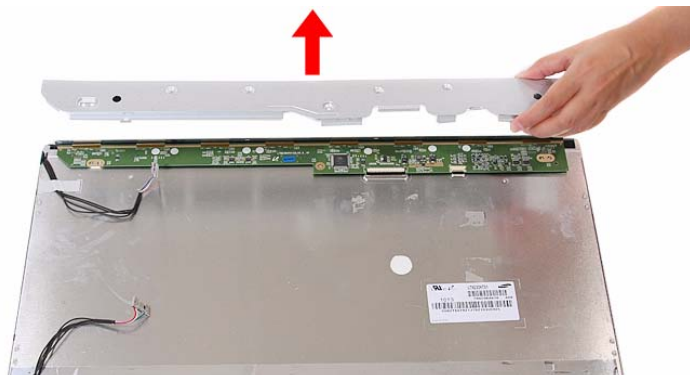

Removing the Webcam Module

1. Remove the LCD assembly by following the procedure described on page 54.
2. Push the tabs securing the webcam module.

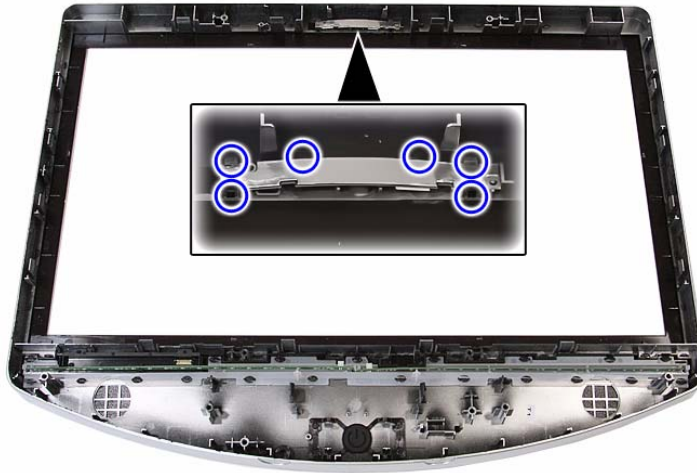

3. Push the tabs securing the webcam module, then remove the module from the front bezel.

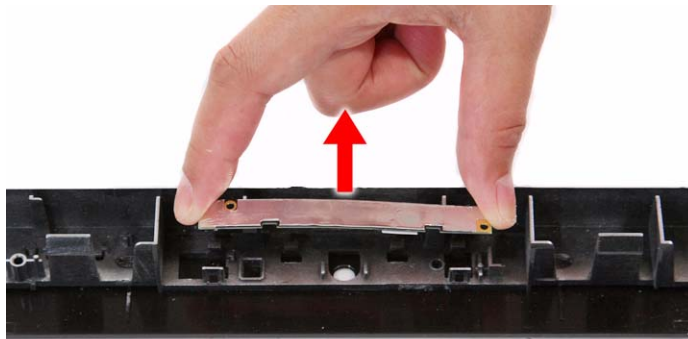

Removing the Capacitive LED Board

1. Remove the LCD assembly by following the procedure described on page 54.
2. Remove the capacitive LED board cover.

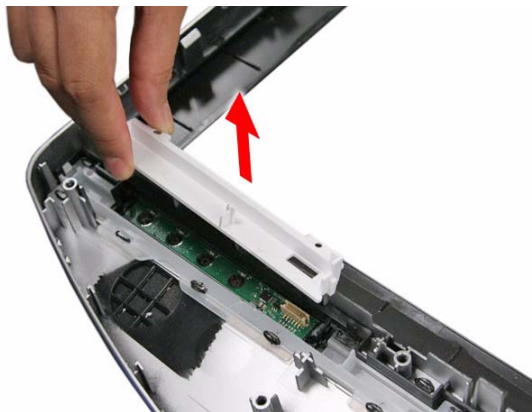

3. Pry the capacitive LED board from the front bezel.



Removing the Light Bars

1. Remove the LCD assembly by following the procedure described on page 54.
2. Push the tabs securing both ends of the two light bars.



3. Remove the light bars from the front bezel.



Troubleshooting

This chapter lists the POST error indicators and BIOS beep codes, as well general troubleshooting instructions.

Hardware Diagnostic Procedure

1. Obtain as much detail as possible about the symptoms of the system failure.
2. Verify the symptoms by attempting to recreate the failure by running the diagnostic tests or repeating the same operation.
3. Refer to “Power System Check” procedure on the next section and the “Beep Codes” section on page 76 to determine which corrective action to take.

System Check Procedures

IMPORTANT The diagnostic tests described in this chapter are only intended to test Acer products. Non-Acer products, prototype cards, or modified options can give false errors and invalid system responses.

Power System Check

If the system can be powered on, skip this section. Proceed to the “System Internal Inspection” procedure on the next page.

If the system will not power on, do the following:

- Check if the power cable is properly connected to the AC power jack and a functional AC power source.
- Check if the voltage selector switch is set to the correct voltage setting.

System External Inspection

1. Inspect the power and LED indicators on the front panel. Go to “Front View” section on page 3 for the location and description of the LED behaviour.
2. Make sure that the ventilation slots on the rear panel are not blocked.
3. Make sure that there is no point of contact in the system that can cause a power short.

If the cause of the failure is still can not be determined, perform the “System Internal Inspection” procedure described on the next page.

System Internal Inspection

1. Turn off the power to the computer and all peripherals.
2. Unplug the power cord from the computer.
3. Unplug the network cable and all connected peripheral devices from the computer.
4. Place the computer on a flat, steady surface.
5. Remove the side panel as described in page 20.
6. Verify that the processor, memory module(s), and expansion board(s) are properly seated.
7. Verify that all power and data cables are firmly and properly attached to the installed drives.
8. Verify that all cable connections inside the system are firmly and properly attached to their appropriate mainboard connectors.
9. Verify that all components are Acer-qualified and supported.
10. Reinstall the side panel.
11. Power on the system.

If the cause of the failure is still can not be determined, review the POST messages and BIOS checkpoints during the system startup.

Checkpoints

A checkpoint is either a byte or word value output to I/O port 80h. The BIOS outputs checkpoints during bootblock and Power-On Self Test (POST) to indicate the task the system is currently executing. Checkpoints are very useful in aiding software developers or technicians in debugging problems that occur during the pre-boot process.

Viewing BIOS Checkpoints

Viewing all checkpoints generated by the BIOS requires a checkpoint card, also referred to as a POST card or POST diagnostic card. These are ISA or PCI add-in cards that show the value of I/O port 80h on a LED display. Checkpoints may appear on the bottom right corner of the screen during POST. This display method is limited, since it only displays checkpoints that occur after the video card has been activated.

NOTE Please note that checkpoints may differ between different platforms based on system configuration. Checkpoints may change due to vendor requirements, system chipset or option ROMs from add-in PCI devices.

Boot Block Initialization Code Checkpoints

The boot block initialization code sets up the chipset, memory, and other components before system memory is available. The following table describes the type of checkpoints that may occur during the boot block initialization portion of the BIOS.

Checkpoint	Description
Before D1	Early chipset initialization is done. Early super I/O initialization is done including RTC and keyboard controller. NMI is disabled.
D1	Perform keyboard controller BAT test. Check if waking up from power management suspend state. Save power-on CPUID value in scratch CMOS.
D0	Go to flat mode with 4GB limit and GA20 enabled. Verify the bootblock checksum.
D2	Disable CACHE before memory detection. Execute full memory sizing module. Verify that flat mode is enabled.
D3	If memory sizing module not executed, start memory refresh and do memory sizing in bootblock code. Do additional chipset initialization. Re-enable CACHE. Verify that flat mode is enabled.
D4	Test base 512 KB memory. Adjust policies and cache first 8 MB. Set stack.

Checkpoint	Description
D5	Bootblock code is copied from ROM to lower system memory and control is given to it. BIOS now executes out of RAM.
D6	Both key sequence and OEM specific method is checked to determine if BIOS recovery is forced. Main BIOS checksum is tested. If BIOS recovery is necessary, control flows to checkpoint E0. See the "Boot Block Recovery Code Checkpoints" section for more information.
D7	Restore CPUID value back into register. The Bootblock Runtime interface module is moved to system memory and control is given to it. Determine whether to execute serial flash.
D8	The Runtime module is uncompressed into memory. CPUID information is stored in memory.
D9	Store the Uncompressed pointer for future use in PMM. Copying Main BIOS into memory. Leaves all RAM below 1 MB Read-Write including E000 and F000 shadow areas but closing SMRAM.
DA	Restore CPUID value back into register. Give control to BIOS POST (ExecutePOSTKernel). See the "POST Code Checkpoints" section for more information.

Boot Block Recovery Code Checkpoints

The boot block recovery code gets control when the BIOS determines that a BIOS recovery is required because the user has forced the update or the BIOS checksum is corrupt. Refer to "BIOS Recovery" section on page 77 for more information. The following table describes the type of checkpoints that may occur during the boot block recovery portion of the BIOS.

Checkpoint	Description
E0	Initialize the floppy controller in the super I/O. Some interrupt vectors are initialized. DMA controller is initialized. 8259 interrupt controller is initialized. L1 cache is enabled.
E9	Set up floppy controller and data. Attempt to read from floppy.
EA	Enable ATAPI hardware. Attempt to read from ARMD and ATAPI CDROM.
EB	Disable ATAPI hardware. Jump back to checkpoint E9.
EF	Read error occurred on media. Jump back to checkpoint EB.
E9 or EA	Determine information about root directory of recovery media.
F0	Search for pre-defined recovery file name in root directory.
F1	Recovery file not found.
F2	Start reading FAT table and analyze FAT to find the clusters occupied by the recovery file.
F3	Start reading the recovery file cluster by cluster.
F5	Disable L1 cache.
FA	Check the validity of the recovery file configuration to the current configuration of the flash part.
FB	Make flash write enabled through chipset and OEM specific method. Detect proper flash part. Verify that the found flash part size equals the recovery file size.
F4	The recovery file size does not equal the found flash part size.
FC	Erase the flash part.
FD	Program the flash part.
FF	The flash has been updated successfully. Make flash write disabled. Disable ATAPI hardware. Restore CPUID value back into register. Give control to F000 ROM at F000:FFF0h.

POST Code Checkpoints

The POST code checkpoints are the largest set of checkpoints during the BIOS preboot process. The following table describes the type of checkpoints that may occur during the POST portion of the BIOS.

Checkpoint	Description
03	Disable NMI, Parity, video for EGA, and DMA controllers. Initialize BIOS, POST, Runtime data area. Also initialize BIOS modules on POST entry and GPNV area. Initialized CMOS as mentioned in the Kernel Variable "wCMOSFlags."
04	Check CMOS diagnostic byte to determine if battery power is OK and CMOS checksum is OK. Verify CMOS checksum manually by reading storage area. If the CMOS checksum is bad, update CMOS with power-on default values and clear passwords. Initialize status register A. Initializes data variables that are based on CMOS setup questions. Initializes both the 8259 compatible PICs in the system
05	Initializes the interrupt controlling hardware (generally PIC) and interrupt vector table.
06	Do R/W test to CH-2 count reg. Initialize CH-0 as system timer. Install the POSTINT1Ch handler. Enable IRQ-0 in PIC for system timer interrupt. Traps INT1Ch vector to "POSTINT1ChHandlerBlock."
08	Initializes the CPU. The BAT test is being done on KBC. Program the keyboard controller command byte is being done after Auto detection of KB/MS using AMI KB-5.
0A	Initializes the 8042 compatible Key Board Controller.
0B	Detects the presence of PS/2 mouse.
0C	Detects the presence of Keyboard in KBC port.
0E	Testing and initialization of different Input Devices. Also, update the Kernel Variables. Traps the INT09h vector, so that the POST INT09h handler gets control for IRQ1. Uncompress all available language, BIOS logo, and Silent logo modules.
13	Early POST initialization of chipset registers.
24	Uncompress and initialize any platform specific BIOS modules. GPNV is initialized at this checkpoint.
30	Initialize System Management Interrupt.
2A	Initializes different devices through DIM. See DIM Code Checkpoints section for more information.
2C	Initializes different devices. Detects and initializes the video adapter installed in the system that have optional ROMs.
2E	Initializes all the output devices.
31	Allocate memory for ADM module and uncompress it. Give control to ADM module for initialization. Initialize language and font modules for ADM. Activate ADM module.
33	Initializes the silent boot module. Set the window for displaying text information.
37	Displaying sign-on message, CPU information, setup key message, and any OEM specific information.
38	Initializes different devices through DIM. See DIM Code Checkpoints section for more information. USB controllers are initialized at this point.
39	Initializes DMAC-1 & DMAC-2.
3A	Initialize RTC date/time.
3B	Test for total memory installed in the system. Also, Check for DEL or ESC keys to limit memory test. Display total memory in the system.

Checkpoint	Description
3C	Mid POST initialization of chipset registers.
40	Detect different devices (Parallel ports, serial ports, and coprocessor in CPU, ... etc.) successfully installed in the system and update the BDA, EBDA...etc.
50	Programming the memory hole or any kind of implementation that needs an adjustment in system RAM size if needed.
52	Updates CMOS memory size from memory found in memory test. Allocates memory for Extended BIOS Data Area from base memory. Programming the memory hole or any kind of implementation that needs an adjustment in system RAM size if needed.
60	Initializes Num-Lock status and programs the KBD typematic rate.
75	Initialize Int-13 and prepare for IPL detection.
78	Initializes IPL devices controlled by BIOS and option ROMs.
7A	Initializes remaining option ROMs.
7C	Generate and write contents of ESCD in NVRam.
84	Log errors encountered during POST.
85	Display errors to the user and gets the user response for error.
87	Execute BIOS setup if needed / requested. Check boot password if installed.
8C	Late POST initialization of chipset registers.
8E	Program the peripheral parameters. Enable/Disable NMI as selected.
90	Late POST initialization of system management interrupt.
A0	Check boot password if installed.
A1	Clean-up work needed before booting to OS.
A2	Takes care of runtime image preparation for different BIOS modules. Fill the free area in F000h segment with 0FFh. Initializes the Microsoft IRQ Routing Table. Prepares the runtime language module. Disables the system configuration display if needed.
A4	Initialize runtime language module. Display boot option popup menu.
A7	Displays the system configuration screen if enabled. Initialize the CPU's before boot, which includes the programming of the MTRR's.
A8	Prepare CPU for OS boot including final MTRR values.
A9	Wait for user input at config display if needed.
AA	Uninstall POST INT1Ch vector and INT09h vector. Deinitializes the ADM module.
AB	Prepare BBS for Int 19 boot.
AC	End of POST initialization of chipset registers.
B1	Save system context for ACPI.
00	Passes control to OS Loader (typically INT19h).

DIM Code Checkpoints

The Device Initialization Manager (DIM) gets control at various times during BIOS POST to initialize different system busses. The following table describes the main checkpoints where the DIM module is accessed.

Checkpoint	Description
2A	Initialize different buses and perform the following functions: Reset, Detect, and Disable (function 0); Static Device Initialization (function 1); Boot Output Device Initialization (function 2). Function 0 disables all device nodes, PCI devices, and PnP ISA cards. It also assigns PCI bus numbers. Function 1 initializes all static devices that include manual configured onboard peripherals, memory and I/O decode windows in PCI-PCI bridges, and noncompliant PCI devices. Static resources are also reserved. Function 2 searches for and initializes any PnP, PCI, or AGP video devices.
38	Initialize different buses and perform the following functions: Boot Input Device Initialization (function 3); IPL Device Initialization (function 4); General Device Initialization (function 5). Function 3 searches for and configures PCI input devices and detects if system has standard keyboard controller. Function 4 searches for and configures all PnP and PCI boot devices. Function 5 configures all onboard peripherals that are set to an automatic configuration and configures all remaining PnP and PCI devices.

POST Error Indicators

When a system error is detected during POST (Power On Self Text), the Setup utility will switch to diagnostic mode and will either:

- Displays a POST error message, or
- Emits a series of beep codes

POST Error Messages

POST error messages tell users what failure the system has detected. Some error messages could be related to a hardware device. Others may indicate a problem with a device configuration. In some cases an error message may include recommendations for troubleshooting or require that you press the **Enter** key to display recommendations. Follow the instructions on the screen. It is recommended that you correct the error before proceeding, even if the computer appears to boot successfully.

IMPORTANT If your system fails after you make changes in the Setup menus, reboot the computer, enter Setup again and load Setup defaults to correct the error.

Memory

Message	Description
Gate20 Error	The BIOS is unable to properly control the mainboard's Gate A20 function, which controls access of memory over 1 MB. This may indicate a problem with the mainboard.
Multi-Bit ECC Error	This message will only occur on systems using ECC enabled memory modules. ECC memory has the ability to correct single-bit errors that may occur from faulty memory modules. A multiple bit corruption of memory has occurred, and the ECC memory algorithm cannot correct it. This may indicate a defective memory module.
Parity Error	Fatal Memory Parity Error. System halts after displaying this message.
RAM R/W test failed	This message is displayed by the AMIBIOS8 when the RAM read/write test fails.
CMOS Memory Size Wrong	The base memory (memory below 1MB) size that is reported in the CMOS (offset 15h) mismatches with the actual size detected. This condition may occur when the hole is set at 512K base memory or when CMOS is corrupted.

Boot

Message	Description
Boot Failure...	This is a generic message indicating the BIOS could not boot from a particular device. This message is usually followed by other information concerning the device.
Invalid Boot Diskette	A diskette was found in the drive, but it is not configured as a bootable diskette.
Drive Not Ready	The BIOS was unable to access the drive because it indicated it was not ready for data transfer. This is often reported by drives when no media is present.
A: Drive Error	The BIOS attempted to configure the A: drive during POST, but was unable to properly configure the device. This may be due to a bad cable or faulty diskette drive.
B: Drive Error	The BIOS attempted to configure the B: drive during POST, but was unable to properly configure the device. This may be due to a bad cable or faulty diskette drive.
Insert BOOT diskette in A:	The BIOS attempted to boot from the A: drive, but could not find a proper boot diskette. Reboot and Select proper Boot device or Insert Boot Media in selected Boot device BIOS could not find a bootable device in the system and/or removable media drive does not contain media.
Reboot and select proper boot device or Insert boot media in selected boot device	BIOS could not find a bootable device in the system and/or removable media drive does not contain media.
NO ROM BASIC	This message occurs on some systems when no bootable device can be detected.

Storage Device

Message	Description
Primary Master Hard Disk Error	The IDE/ATAPI device configured as Primary Master could not be properly initialized by the BIOS. This message is typically displayed when the BIOS is trying to detect and configure IDE/ATAPI devices in POST.
Primary Slave Hard Disk Error	The IDE/ATAPI device configured as Primary Slave could not be properly initialized by the BIOS. This message is typically displayed when the BIOS is trying to detect and configure IDE/ATAPI devices in POST.
Secondary Master Hard Disk Error	The IDE/ATAPI device configured as Secondary Master could not be properly initialized by the BIOS. This message is typically displayed when the BIOS is trying to detect and configure IDE/ATAPI devices in POST.
Secondary Slave Hard Disk Error	The IDE/ATAPI device configured as Secondary Slave could not be properly initialized by the BIOS. This message is typically displayed when the BIOS is trying to detect and configure IDE/ATAPI devices in POST.
3rd Master Hard Disk Error	The IDE/ATAPI device configured as Master in the 3rd IDE controller could not be properly initialized by the BIOS. This message is typically displayed when the BIOS is trying to detect and configure IDE/ATAPI devices in POST.
3rd Slave Hard Disk Error	The IDE/ATAPI device configured as Slave in the 3rd IDE controller could not be properly initialized by the BIOS. This message is typically displayed when the BIOS is trying to detect and configure IDE/ATAPI devices in POST.
4th Master Hard Disk Error	The IDE/ATAPI device configured as Master in the 4th IDE controller could not be properly initialized by the BIOS. This message is typically displayed when the BIOS is trying to detect and configure IDE/ATAPI devices in POST.
4th Slave Hard Disk Error	The IDE/ATAPI device configured as Slave in the 4th IDE controller could not be properly initialized by the BIOS. This message is typically displayed when the BIOS is trying to detect and configure IDE/ATAPI devices in POST.
5th Master Hard Disk Error	The IDE/ATAPI device configured as Master in the 5th IDE controller could not be properly initialized by the BIOS. This message is typically displayed when the BIOS is trying to detect and configure IDE/ATAPI devices in POST.
5th Slave Hard Disk Error	The IDE/ATAPI device configured as Slave in the 5th IDE controller could not be properly initialized by the BIOS. This message is typically displayed when the BIOS is trying to detect and configure IDE/ATAPI devices in POST.
6th Master Hard Disk Error	The IDE/ATAPI device configured as Master in the 6th IDE controller could not be properly initialized by the BIOS. This message is typically displayed when the BIOS is trying to detect and configure IDE/ATAPI devices in POST.
6th Slave Hard Disk Error	The IDE/ATAPI device configured as Slave in the 6th IDE controller could not be properly initialized by the BIOS. This message is typically displayed when the BIOS is trying to detect and configure IDE/ATAPI devices in POST.
Primary Master Drive - ATAPI Incompatible	The IDE/ATAPI device configured as Primary Master failed an ATAPI compatibility test. This message is typically displayed when the BIOS is trying to detect and configure IDE/ATAPI devices in POST.
Primary Slave Drive - ATAPI Incompatible	The IDE/ATAPI device configured as Primary Slave failed an ATAPI compatibility test. This message is typically displayed when the BIOS is trying to detect and configure IDE/ATAPI devices in POST.
Secondary Master Drive - ATAPI Incompatible	The IDE/ATAPI device configured as Secondary Master failed an ATAPI compatibility test. This message is typically displayed when the BIOS is trying to detect and configure IDE/ATAPI devices in POST.
Secondary Slave Drive - ATAPI Incompatible	The IDE/ATAPI device configured as Secondary Slave failed an ATAPI compatibility test. This message is typically displayed when the BIOS is trying to detect and configure IDE/ATAPI devices in POST.
3rd Master Drive - ATAPI Incompatible	The IDE/ATAPI device configured as Master in the 3rd IDE controller failed an ATAPI compatibility test. This message is typically displayed when the BIOS is trying to detect and configure IDE/ATAPI devices in POST.

Message	Description
3rd Slave Drive - ATAPI Incompatible	The IDE/ATAPI device configured as Slave in the 3rd IDE controller failed an ATAPI compatibility test. This message is typically displayed when the BIOS is trying to detect and configure IDE/ATAPI devices in POST.
4th Master Drive - ATAPI Incompatible	The IDE/ATAPI device configured as Master in the 4th IDE controller failed an ATAPI compatibility test. This message is typically displayed when the BIOS is trying to detect and configure IDE/ATAPI devices in POST.
4th Slave Drive - ATAPI Incompatible	The IDE/ATAPI device configured as Slave in the 4th IDE controller failed an ATAPI compatibility test. This message is typically displayed when the BIOS is trying to detect and configure IDE/ATAPI devices in POST.
5th Master Drive - ATAPI Incompatible	The IDE/ATAPI device configured as Master in the 5th IDE controller failed an ATAPI compatibility test. This message is typically displayed when the BIOS is trying to detect and configure IDE/ATAPI devices in POST.
5th Slave Drive - ATAPI Incompatible	The IDE/ATAPI device configured as Slave in the 5th IDE controller failed an ATAPI compatibility test. This message is typically displayed when the BIOS is trying to detect and configure IDE/ATAPI devices in POST.
6th Master Drive - ATAPI Incompatible	The IDE/ATAPI device configured as Master in the 6th IDE controller failed an ATAPI compatibility test. This message is typically displayed when the BIOS is trying to detect and configure IDE/ATAPI devices in POST.
6th Slave Drive - ATAPI Incompatible	The IDE/ATAPI device configured as Slave in the 6th IDE controller failed an ATAPI compatibility test. This message is typically displayed when the BIOS is trying to detect and configure IDE/ATAPI devices in POST.
S.M.A.R.T. Capable but Command Failed	The BIOS tried to send a S.M.A.R.T. message to a hard disk, but the command transaction failed. This message can be reported by an ATAPI device using the S.M.A.R.T. error reporting standard. S.M.A.R.T. failure messages may indicate the need to replace the hard disk.
S.M.A.R.T. Command Failed	The BIOS tried to send a S.M.A.R.T. message to a hard disk, but the command transaction failed. This message can be reported by an ATAPI device using the S.M.A.R.T. error reporting standard. S.M.A.R.T. failure messages may indicate the need to replace the hard disk.
S.M.A.R.T. Status BAD, Backup and Replace	A S.M.A.R.T. capable hard disk sends this message when it detects an imminent failure. This message can be reported by an ATAPI device using the S.M.A.R.T. error reporting standard. S.M.A.R.T. failure messages may indicate the need to replace the hard disk.
S.M.A.R.T. Capable and Status BAD	A S.M.A.R.T. capable hard disk sends this message when it detects an imminent failure. This message can be reported by an ATAPI device using the S.M.A.R.T. error reporting standard. S.M.A.R.T. failure messages may indicate the need to replace the hard disk.

Virus-related

Message	Description
BootSector Write!!	The BIOS has detected software attempting to write to a drive's boot sector. This is flagged as possible virus activity. This message will only be displayed if Virus Detection is enabled in AMIBIOS setup.
VIRUS: Continue (Y/N)?	If the BIOS detects possible virus activity, it will prompt the user. This message will only be displayed if Virus Detection is enabled in AMIBIOS setup.

System Configuration

Message	Description
DMA-1 Error	Error initializing primary DMA controller. This is a fatal error, often indication a problem with system hardware.
DMA-2 Error	Error initializing secondary DMA controller. This is a fatal error, often indication a problem with system hardware.
DMA Controller Error	POST error while trying to initialize the DMA controller. This is a fatal error, often indication a problem with system hardware.
Checking NVRAM... Update Failed	BIOS could not write to the NVRAM block. This message appears when the FLASH part is write-protected or if there is no FLASH part (System uses a PROM or EPROM).
Microcode Error	BIOS could not find or load the CPU Microcode Update to the CPU. This message only applies to INTEL CPUs. The message is most likely to appear when a brand new CPU is installed in a mainboard with an outdated BIOS. In this case, the BIOS must be updated to include the Microcode Update for the new CPU.
NVRAM Checksum Bad, NVRAM Cleared	There was an error in while validating the NVRAM data. This causes POST to clear the NVRAM data.
Resource Conflict	More than one system device is trying to use the same non-shareable resources (Memory or I/O).
NVRAM Ignored	The NVRAM data used to store Plug'n'Play (PnP) data was not used for system configuration in POST.
NVRAM Bad	The NVRAM data used to store Plug'n'Play (PnP) data was not used for system configuration in POST due to a data error.
Static Resource Conflict	Two or more Static Devices are trying to use the same resource space (usually Memory or I/O).
PCI I/O conflict	A PCI adapter generated an I/O resource conflict when configured by BIOS POST.
PCI ROM conflict	A PCI adapter generated an I/O resource conflict when configured by BIOS POST.
PCI IRQ conflict	A PCI adapter generated an I/O resource conflict when configured by BIOS POST.
PCI IRQ routing table error	BIOS POST (DIM code) found a PCI device in the system but was unable to figure out how to route an IRQ to the device. Usually this error is causing by an incomplete description of the PCI Interrupt Routing of the system.
Timer Error	Indicates an error while programming the count register of channel 2 of the 8254 timer. This may indicate a problem with system hardware.
Refresh timer test failed	BIOS POST found that the refresh timer hardware failed to pass the Refresh Retrace Test.
Interrupt Controller-1 error	BIOS POST could not initialize the Master Interrupt Controller. This may indicate a problem with system hardware.
Interrupt Controller-2 error	BIOS POST could not initialize the Slave Interrupt Controller. This may indicate a problem with system hardware.

CMOS

Message Displayed	Description
CMOS Date/Time Not Set	The CMOS date and/or time are invalid. This error can be resolved by readjusting the system time in AMIBIOS Setup.
CMOS Battery Low	CMOS battery is low. This message usually indicates that the CMOS battery needs to be replaced. It could also appear when the user intentionally discharges the CMOS battery.
CMOS Settings Wrong	CMOS settings are invalid. This error can be resolved by using AMIBIOS Setup.
CMOS Checksum Bad	CMOS contents failed the Checksum check. Indicates that the CMOS data has been changed by a program other than the BIOS or that the CMOS is not retaining its data due to malfunction. This error can typically be resolved by using AMIBIOS Setup.

Miscellaneous

Message Displayed	Description
KBC BAT Test failed	Keyboard controller BAT test failed. This may indicate a problem with keyboard controller initialization.
Keyboard Error	Keyboard is not present or the hardware is not responding when the keyboard controller is initialized.
PS/2 Keyboard not found	PS/2 keyboard support is enabled in the BIOS setup but the device is not detected.
PS/2 Mouse not found	PS/2 mouse support is enabled in the BIOS setup but the device is not detected.
Keyboard/Interface Error	Keyboard controller failure. This may indicate a problem with system hardware.
Unlock Keyboard	PS/2 keyboard is locked. User needs to unlock the keyboard to continue the BIOS POST.
System Halted	The system has been halted. A reset or power cycle is required to reboot the machine. This message appears after a fatal error has been detected.
<INS> Pressed	Indicates that <INS> key is pressed during the BIOS POST. The POST will load and use default CMOS settings.
Password check failed	The password entered does not match the password set in the setup. This condition may occur for both Supervisor and User password verification.
Unknown BIOS error. Error code = 004Ah	This message is displayed when ADM module is not present in the AMIBIOS8 ROM.
Unknown BIOS error. Error code = 004Bh	This message is displayed when language module is not present in the AMIBIOS8 ROM.
Floppy Controller Failure	Error in initializing legacy Floppy Controller.

Index of Symptom-to-FRU Error Messages

To use the information in this section to diagnose a problem:

1. Find the error symptom in the left column.
2. If directed to a check procedure, replace the FRU indicated in the check procedure.
If no check procedure is indicated, the first Action/FRU item listed in the right column is the most likely cause.

NOTE If you cannot find a symptom or an error in this list and the problem remains, see “Undetermined Problems” on page 65.

Processor/Processor Fan-related Symptoms

Symptom/Error	Action/FRU
Processor fan does not run but power supply fan runs.	<ul style="list-style-type: none"> • Ensure the system is not in power saving mode. • With the system powered on, measure the voltage of the processor fan connector. Its reading should be +12Vdc. If the reading shows normal, but the fan still does not work, then replace the heat sink fan. • Mainboard
Processor test failed.	<ul style="list-style-type: none"> • Processor • Mainboard

NOTE Normally, the processor fan should be operative, and the processor clock setting should be exactly set to match its speed requirement before diagnosing any processor problems.

Mainboard and Memory-related Symptoms

Symptom/Error	Action/FRU
Memory test failed.	<ul style="list-style-type: none"> • Memory module • Mainboard
Incorrect memory size shown or repeated during POST.	<ul style="list-style-type: none"> • Insert the memory modules in the DIMM sockets properly, then reboot the system. • Memory module • Mainboard
System works but fails to enter power saving mode when the Power Management Mode is set to Enabled.	<ul style="list-style-type: none"> • Enter CMOS Setup and load the default settings. In Windows systems, check settings in Power Management Property of the Control Panel. • Reload software from Recovery CD.
Blinking cursor only; system does not work.	<ul style="list-style-type: none"> • IDE drive connection/cables • IDE disk drives • See “Undetermined Problems”. • Mainboard

NOTE Ensure the memory modules are installed properly and the contact leads are clean before diagnosing any system problems.

Hard Disk Drive-related Symptoms

Symptom/Error	Action/FRU
Hard disk drive test failed.	<ul style="list-style-type: none"> • Enter CMOS Setup and load the default settings. • Hard disk drive cable • Hard disk drive • Mainboard
Hard disk drive cannot format completely.	<ul style="list-style-type: none"> • Enter CMOS Setup and load the default settings. • Hard disk drive cable • Hard disk drive • Mainboard
Hard disk drive has write error.	<ul style="list-style-type: none"> • Enter CMOS Setup and load the default settings. • Hard disk drive
Hard disk drive LED fails to light, but system operates normally.	<ul style="list-style-type: none"> • With the system power on, measure the voltage of the HDD LED connector. • HDD LED cable

NOTE Make sure the hard disk drive is configured correctly in CMOS Setup and that cable/jumper are set correctly before diagnosing any hard disk drive problems. (If only one drive is installed, please make sure the drive is connected to master connector or the drive is set to master.)

Optical Disc Drive-related Symptoms

Symptom/Error	Action/FRU
CD/DVD-ROM drive LED doesn't come on but works normally.	<ul style="list-style-type: none"> • Enter CMOS Setup and load the default settings. • DIMM • Mainboard
CD/DVD-ROM drive LED flashes for more than 30 seconds before LED shutting off. Software asks to reinstall disc. Software displays a reading CD/DVD error.	<ul style="list-style-type: none"> • CD/DVD-ROM may have dirt or foreign material on it. Check with a known good disc. • CD/DVD-ROM is not inserted properly. • CD/DVD-ROM is damaged.
CD/DVD-ROM drive cannot load or eject when the system is turned on and its eject button is pressed and held.	<ul style="list-style-type: none"> • Disconnect all cables from CD/DVD-ROM drive except power cable, then press the eject button to try to unload the disc. • CD/DVD-ROM drive power cable • CD/DVD-ROM drive
CD/DVD-ROM drive does not read and there are no messages are displayed.	<ul style="list-style-type: none"> • CD may have dirt or foreign material on it. Check with a known good disc. • Ensure the CD/DVD-ROM driver is installed properly. • CD/DVD-ROM drive.
CD/DVD-ROM drive can play audio CD but no sound output.	<ul style="list-style-type: none"> • Ensure the headphone jack of the CD/DVD-ROM has an output. • Turn up the sound volume. • Speaker power/connection/cable. • CD/DVD-ROM drive.

NOTE Make sure the optical disc drive is configured correctly in CMOS Setup, the cable/jumper are set correctly and the drive's optical lens is clean before diagnosing any optical drive problems.

Real-Time Clock-related Symptoms

Symptom/Error	Action/FRU
Real-time clock is inaccurate.	<ul style="list-style-type: none"> • Ensure the information in the Standard CMOS Feature of BIOS Setup is set correctly. • RTC battery • Mainboard

Audio-related Symptoms

Symptom/Error	Action/FRU
Audio software program invoked but no sound comes from speakers.	<ul style="list-style-type: none"> • Speaker power/connection/cable

Modem-related Symptoms

Symptom/Error	Action/FRU
Modem ring cannot wake up system from suspend mode.	<ul style="list-style-type: none"> • For an external modem, make sure Power on By Ring in BIOS Setup or Power Management is set to Enabled. For the PCI modem, make sure Wake up by PCI card is set to Enabled. • If a PCI modem card is used, reinsert the modem card to the PCI slot firmly or replace the modem card. • In Win 98, ensure the telephone application is configured correctly for your modem and set to receive messages and/or fax.
Data/fax modem software program invoked but cannot receive/send data/fax	<ul style="list-style-type: none"> • Ensure the modem card is installed properly.
Fax/voice modem software program invoked but has no sound output. (Data files are received normally; voice from modem cannot be produced, but system sound feature works normally.)	<ul style="list-style-type: none"> • Ensure the modem voice-in cable from modem adapter card is connected to the mainboard

Video and Monitor-related Symptoms

Symptom/Error	Action/FRU
Video memory test failed.Video adapter failed.	<ul style="list-style-type: none"> • Remove all non-factory-installed cards. • Load default settings (if screen is readable). • Mainboard
Display problem <ul style="list-style-type: none"> • Incorrect colors • No high intensity • Missing, broken, or incorrect characters • Blank monitor (dark) • Blank monitor (bright) • Distorted image • Unreadable monitor 	<ul style="list-style-type: none"> • Monitor signal connection/cable • Monitor • Video adapter card • Mainboard
Display changing colors.	<ul style="list-style-type: none"> • Monitor signal connection/cable • Video adapter card • Mainboard

Printer-related Symptoms

Symptom/Error	Action/FRU
Printing failed.	<ul style="list-style-type: none">• Ensure the printer driver is properly installed. Refer to the printer service manual.• Printer• Printer cable• Mainboard.
Printer problems.	<ul style="list-style-type: none">• Refer to the service manual for the printer.

Keyboard-related Symptoms

Symptom/Error	Action/FRU
Some or all keys on keyboard do not work.	<ul style="list-style-type: none">• Keyboard

Power Supply-related Symptoms

Symptom/Error	Action/FRU
Pressing the power button does not turn off the system. (Only unplugging the power cord from electrical outlet can turn off the system.)	<ul style="list-style-type: none">• Ensure the Soft-off by PWR-BTTN in CMOS Setup (under Power Management) is not set to Instant-off.• Power switch cable assembly
Pressing the power button does not turn on the system	<ul style="list-style-type: none">• Power switch cable assembly.
Executing software shutdown from Windows98 Start menu does not turn off the system. (Only pressing power button can turn off the system).	<ul style="list-style-type: none">• Enter CMOS Setup and load the default settings.• Reload software from Recovery CD.
No system power, or power supply fan is not running.	<ul style="list-style-type: none">• Power supply• Mainboard

Beep Codes

When no error message is displayed but the computer stops during POST, listen for beep codes.

Beep	Status	Possible Causes
One short beep.	System ready	System is OK.
Continuous one long beep	Memory not installed or memory error	<ul style="list-style-type: none">• Something is wrong with the memory installed• There is problem accessing the memory (i.e., mainboard problem)
One long beep, then two short beeps and repeat	VGA not installed or VGA error	<ul style="list-style-type: none">• The mainboard can not access the video card for some reasons. Either the video card is not working, its memory is not accessible, or its BIOS may be corrupt.• Something is wrong with the mainboard.
One long beep, then one short beep	BIOS failure	BIOS damaged. Processor jump to boot block to execute the default procedure.
Two short beeps.	CMOS failure	CMOS checksum error

Undetermined Problems

- NOTE**
- Verify that all attached devices are supported by the computer.
 - Verify that the power supply being used at the time of the failure is operating correctly. (See “Power System Check” on page 61)

Follow the procedures below to isolate the failing FRU. Do not isolate non-defective FRU.

1. Power off the computer.
2. Visually check them for damage. If any problems are found, replace the FRU.
3. Remove or disconnect all of the following devices:
 - Non-Acer devices
 - Printer, mouse, and other external devices
 - Hard disk drive
 - DIMM
 - CD/DVD-ROM drive
 - Expansion boards
4. Power on the computer.
5. Determine if the problem has been resolved.
6. If the problem does not recur, reconnect the removed devices one at a time until you find the failed FRU.
If the problem persists, replace the mainboard, and then LCD assembly (one at a time). Do not replace a non-defective FRU.

BIOS Recovery

When you boot up the computer and you hear one long beep, followed by a shorter one, the system BIOS is damaged. This may be caused by an interruption during a BIOS flash procedure (e.g. a power outage) or a corrupted BIOS code, which will cause the system to go into an unbootable state. You need to access and execute the boot block program to reboot the computer and recover the regular BIOS code.

Note the following when restoring the BIOS settings:

- Make sure the computer is connected to a UPS unit during the BIOS recovery process.
- The BIOS crisis recovery disk should be prepared in a computer running the Windows XP or Windows Vista OS.

Creating the BIOS Crisis Recovery Disk

1. Prepare a removable USB storage device with a capacity size greater than 10 MB.
Note that all data on the USB storage device will be cleared during the creation of the crisis disk.
2. Set up a computer running the Windows XP or Windows Vista operating system and plug in the USB storage device into an available USB port.
3. Copy the target BIOS ROM file to the USB storage device and rename it as "amiboot.rom".
4. Unplug the USB storage device.
5. Eject the removable USB storage device from the computer.

Performing a BIOS Recovery

1. Shut down the BIOS failed-computer.
2. Connect the USB storage device containing the "amiboot.rom" file to the failed computer.
3. Press the power button to turn on the computer.
The system will now execute the BIOS recovery process. When the process is complete, four short beeps will be emitted and the computer will automatically reboot.
4. Disconnect the USB storage device from the computer.
5. Press **Delete** to run the CMOS Setup Utility.
6. Press **F9** to load the system default settings.
7. Select **Ok**, then press **Enter**.
8. Press **F9** to save the default settings and close the Setup utility.
9. Select **Ok**, then press **Enter**.

Clearing CMOS

You may need to clear the Setup configuration values (CMOS) if the configuration has been corrupted, or if incorrect settings made in the Setup Utility caused error messages to be unreadable. This procedure will clear the BIOS supervisor password as well.

Use the JBIOS1 jumper to clear the CMOS data.

- 1-2 position: Normal operation (default)
- 2-3 position: Clear CMOS data

To clear the CMOS data:

1. Turn off the power to the computer and all peripherals.
2. Unplug the power cord from the computer.
3. Unplug the network cable and all connected peripheral devices from the computer.
4. Place the computer on a flat, steady surface with the rear cover facing upward.
5. Reinstall the rear cover by following the procedure described on page 28.
6. Remove the wall mount plate by following the procedure described on page 35.
7. Remove the graphics card by following the procedure described on page 37
8. Remove the hard drive by following the procedure described on page 40.
9. If necessary, remove any other assemblies or cables that prevent access to the CMOS clear jumper.
10. Locate the JBIOS1 jumper on the mainboard.

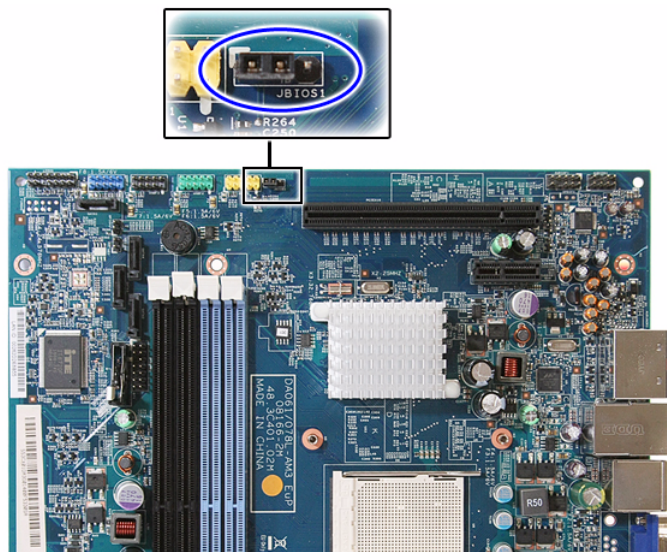

11. Remove the jumper block and set it over the 2-3 pins for 20 to 30 seconds.
12. Return the jumper block to its default 1-2 position.
13. Reinstall the hard drive, graphics card, and the wall mount plate.
14. Reinstall any any other assemblies or cables that have previously been removed.
15. Reinstall the rear cover and the computer stand.
16. Connect the AC power cord to the system.
17. Press the power button  to turn on the computer.
18. During POST, press **Delete** to access the Setup Utility.
19. Press **F9** to load the system default values.
20. Press **F10** to save the changes you made and close the Setup Utility.

System Architecture

This chapter shows the block diagram and board layout of the Packard Bell oneTwo M3350 / oneTwo M3351 / oneTwo L5350 / oneTwo L5351 computer. Procedure for using the G116 hardware gap to clear the BIOS password is also shown.

Block Diagram

The core subsystems of the Packard Bell oneTwo M3350 / oneTwo M3351 / oneTwo L5350 / oneTwo L5351 computer are depicted in the following block diagram.

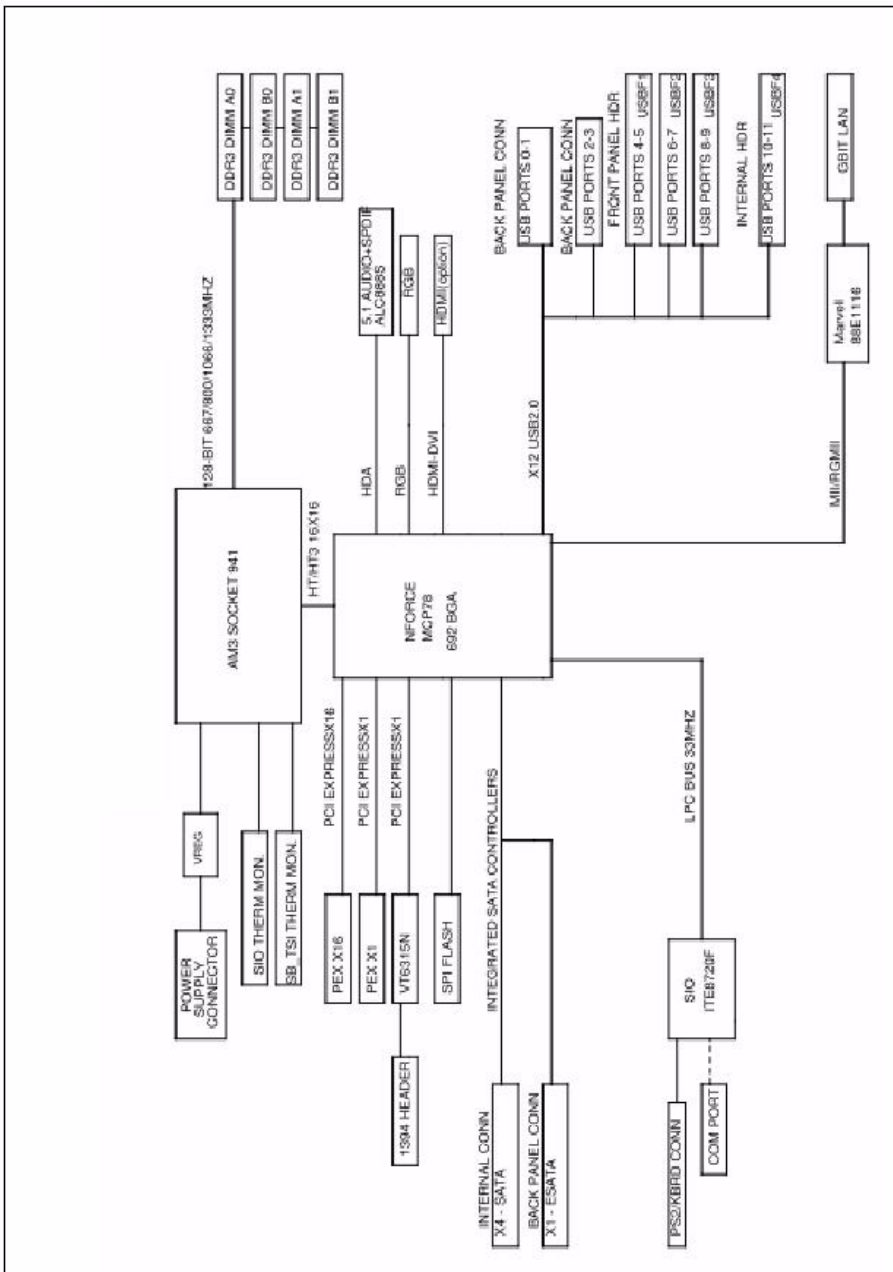

Mainboard Layout

This section shows the major mainboard components.

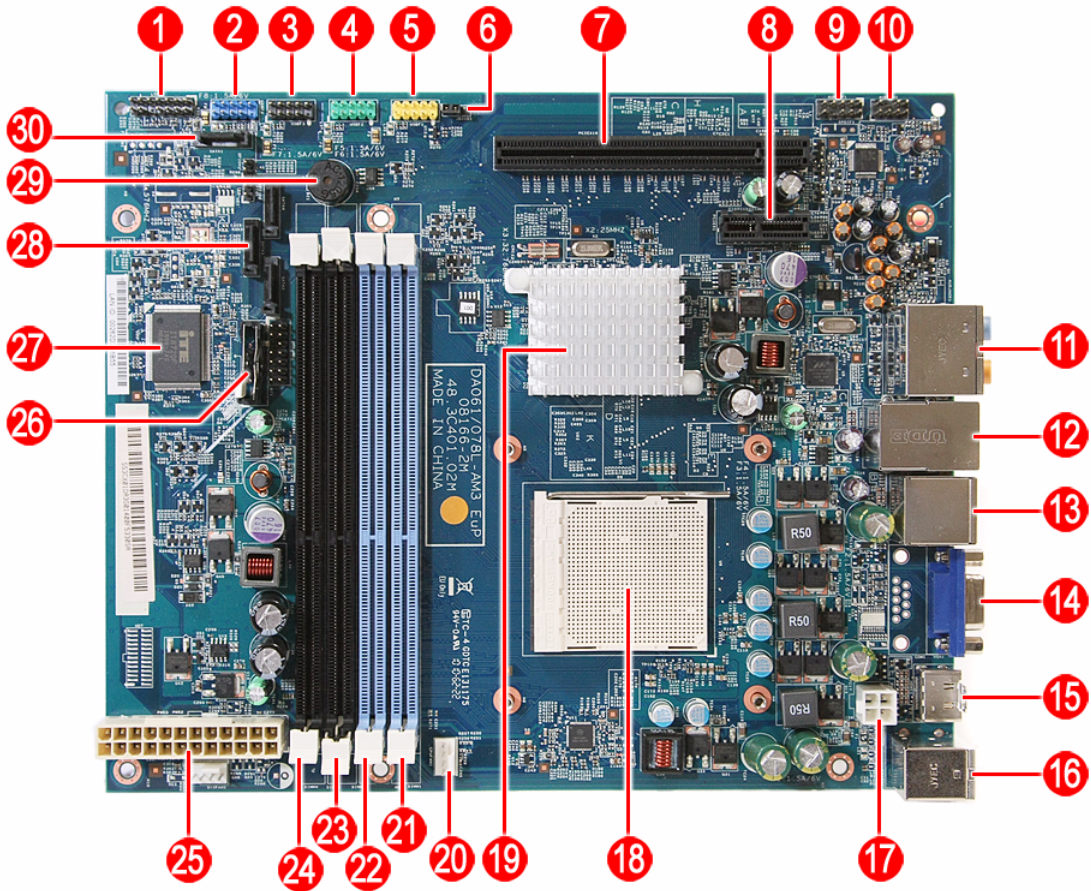

Item	Code	Component
1	LEDH1	Power button/LED cable connector
2	USBF4	USB cable connector
3	USBF3	Front I/O board cable connector
4	USBF2	Front I/O board cable connector
5	USBF1	Card reader function connector
6	JBIOS1	Clear CMOS jumper
7	PCIEX16	PCI Express x16 expansion slot (reserved for graphics card installation)
8	PCIEX1	PCI Express x1 expansion slot (reserved for TV tuner card installation)
9	AUDIOF1	Internal speaker cable connector
10	AUDIOS1	Side I/O board cable connector
11	AUDJACK1	Left panel audio jacks Top: Line-in, line-out, and microphone jacks Bottom: Line-in and line-out jacks
12	USBLAN1	Left: Ethernet port Right: USB ports
13	USBESATA1	Left: USB ports Right: eSATA port
14	VGA1	Monitor port

Item	Code	Component
15	HDMI1	HDMI port
16	KBMSCONN1	Left: PS/2 mouse port Right: PS/2 keyboard port
17	PWR1	4-pin ATX power connector
18	U9	Processor socket
19		nVIDIA GeForce 8200 (MCP78PV) chipset
20	CPUFAN1	Heat sink fan cable connector
21	DIMM1	DDR3 slot 1
22	DIMM2	DDR3 slot 2
23	DIMM3	DDR3 slot 3
24	DIMM4	DDR3 slot 4
25	PWR2	24-pin ATX power connector
26	BT1	RTC battery
27	U22	SIO ITE 8720 controller
28	SATA3	ODD SATA cable connector
29	BZ1	Internal buzzer
30	SATA1	HDD SATA cable connector

Field Replaceable Unit (FRU) List

This chapter gives you the FRU (Field Replaceable Unit) listing of the Packard Bell oneTwo M3350 / oneTwo M3351 / oneTwo L5350 / oneTwo L5351 computer global configurations. Refer to this list when ordering for repair parts or for RMA (Return Merchandise Authorization).

IMPORTANT Part number changes will not be noted in this printed Service Guide. The part numbers listed in this Service Guide may differ from those given to regional AUTHORIZED SERVICE PROVIDERS. You MUST use the local FRU list provided by your regional office to order FRU parts for repair and service of customer machines. Make sure that you are using the most up-to-date information available on your regional web site or channel when ordering FRU parts.

NOTE Follow the local government regulations, or the rules set by your regional office on how to return or dispose of defective parts.



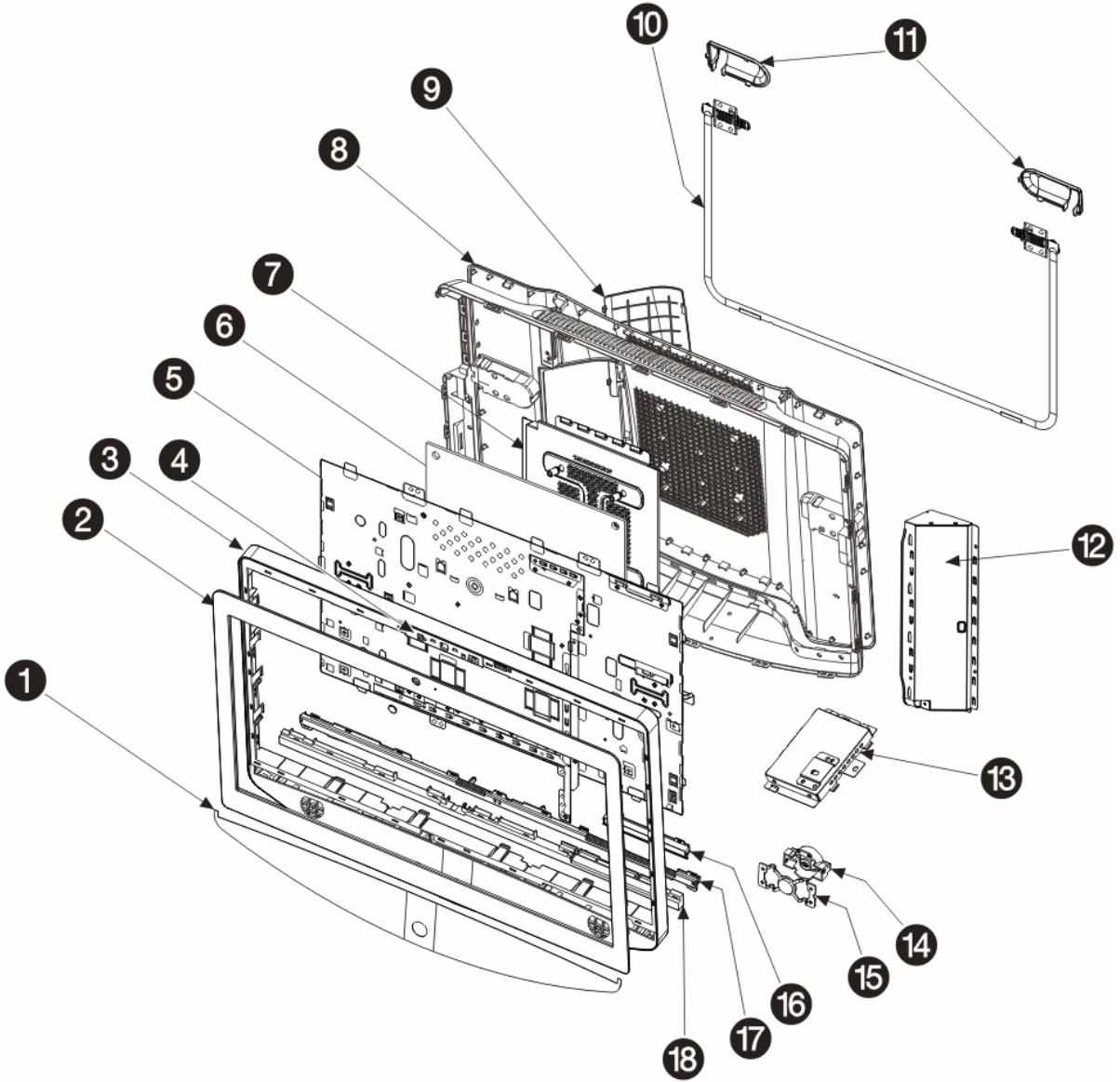



Exploded Diagram



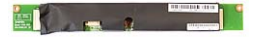



No.	Component	No.	Component
1	Speaker mesh plate	10	Computer stand
2	Front bezel	11	Computer stand shells
3	Front bezel frame	12	Inverter board cover
4	Webcam module	13	USB/audio board cover
5	Main chassis	14	Power button holder
6	Mainboard	15	Power button knob
7	Wall mount plate	16	Capacitive LED board cover
8	Rear cover	17	Light bar guide
9	I/O cable cover	18	Light bar cover

FRU List

System Model: ACER_ONE TWO L5351_PGREENWOOD (No: 91.3CX01.A10G)

Category	Part Name	Part Number
Boards		
Mainboard		
	MAINBOARD DA078L/ABOXER2 EUP W/RTC BATTERY W/O 1394 LF DDRIII 4 DIMM & CPU & MEMORY	MB.SE201.001
Inverter board		
	INVERTER BOARD 23" 4L DARFON VZ.13156.B01	19.21060.231
	INVERTER BOARD 23" 4L SUMIDA IV30260SPEC139	19.21066.231
Power button assembly		
	CAPACITIVE BUTTON BOARD GALLAPHER-TKSTWSGAL001	56.41010.491
	CAPACITIVE BUTTON BOARD NS-GALLAGHER-CY	56.41010.511
Bluetooth module		
	BLUETOOTH BOARD LITEON WB111C-C1 V2.1+EDR	56.25034.021
	BLUETOOTH BOARD XAVI BC10B-04C1 V2.1+EDR	56.25034.011
Webcam module		
	CAMERA 2M 1007 PARKORCHID C04PL037F	56.18007.521
	CAMERA 2M CHICONY CNFA21321004590L	56.18022.521
	CAMERA 2M PRIMAX 50-704A4WNT8	56.18009.521
Touchscreen control board		
	TOUCH CONTROL BOARD IDEACOM MUTI- IDC1650-114U0 RESISTIVE FOR 23	PA.14800.002
	TOUCH CONTROL BOARD IDEACOM MUTI- IDC1650-114U0 RESISTIVE FOR 23	PA.14800.002
Graphics card		
	VGA CARD PCPARTNER 288-1E153-A00AC HD5450 512MB SDDR 3 (64BITS) SAMSUNG DVI HDMI W/LP BKT ROHS 4 LAYER	VG.APC54.513
	VGA CARD ECS 89D386-303408 HD5450 512MB (64BIT) DDR3 DVI HDMI VGA LP BRACKET ROHS	VG.ECS54.511
	VGA CARD ECS 89D386-469013 NV G315 512MB (64BIT) DDR3 DVI HDMI LP BRACKET ROHS	VG.ECS31.5L1
	VGA CARD PCPARTNER 288-1E145-A01AC HD5450 512MB SDDR3 64BITS SAMSUNG DVI HDMI W/LP BRACKET ROHS	VG.APC54.511
	VGA CARD PCPARTNER 288-2E142-A01AC ATI HD5570 1GB DDR 3 128BITS SAMSUNG DVI HDMI W/LP BRACKET ROHS	VG.APC55.711
	VGA CARD PCPARTNER 288-2E142-C01AC HD5570 1GB 128BITS SDDR3 DVI+HDMI LP (NEW HYNIX -1.2)	VG.APC55.732

Category	Part Name	Part Number
Graphics card (continuation)		
	VGA CARD PCPARTNER 288-5N118-A10AC NVIDIA GT320 1GB SDDR3 DVI+HDMI LP (SAMSUNG)	VG.PCPT3.211
	VGA CARD PCPARTNER 288-5N118-C10AC NV GT320 1GB DDR3 DVI+HDMI LP (HYNIX 1.2NS)	VG.PCPT3.213
TV tuner card		
	TV TUNER CARD AVERMEDIA H753-A ATSC	TU.10500.064
	TV TUNER CARD AVERMEDIA H753-D DVB-T	TU.10500.065
Wireless LAN card	WIRELESS LAN BOARD 802.11BGN LITE-ON WN6607LH	NI.10200.041
Processor		
	CPU AMD ATHLON II X2 240 2.8GHZ 2M L2 CACHE 65W REGOR	KC.AT202.240
	CPU AMD ATHLON II X2 245 2.9GHZ 2M L2 CACHE 65W REGOR	KC.AT202.245
	CPU AMD ATHLON II X3 405E 2.3GHZ 1.5M L2 CACHE 45W RANA ATHIIX3405E	KC.AE202.405
	CPU AMD ATHLON II X4 600E 2.2GHZ 2M L2 CACHE 45W PROPUS ATHIIX4600E	KC.AE202.600
	CPU AMD ATHLON II X4 605E 2.3GHZ 2M L2 CACHE 45W PROPUS ATHIIX4605E	KC.AE202.605
	CPU AMD CPU ATHLON II X2 215 65W 2.7G ADX215OCK22GQ	KC.AT202.215
	CPU AMD P PHENOMII 910E AM3+ 2.6G 4X512K 4000 940 65W C-3 QUAD CORE	KC.PE202.910
	CPU AMD PHENOMII X 3 700E 2.4GHZ 7.5M TOTAL CACHE 65W HEKA PHNMII700E	KC.PE202.700
	CPU AMD PHENOMII X 3 705E 2.5GHZ 7.5M TOTAL CACHE 65W HEKA PHNMII705E	KC.PE202.705
	CPU AMD PHENOMII X 4 900E 2.4GHZ 6M TOTAL CACHE 65W DENEK PHNMII900E	KC.PE202.900
Heat sink fan		
	CPU HEATSINK AIR COOLER LGA775 PGGREENWOOD	HI.10800.079
Memory		
	MEMORY ADATA DDR3 1333MHZ 1G UNB-DIMM AD63I1A0816EZ	KN.1GB07.002
	MEMORY APACER DDR3 1333MHZ 1G UNB-DIMM GU502203EP0201 LF 128*8 0.065UM	KN.1GB0B.036
	MEMORY KINGSTON DDR3 1333MHZ 1G ACR128X64D3U1333C9	KN.1GB01.031
	MEMORY SAMSUNG DDR3 1333MHZ 1G UNB-DIMM GU502203EP0201 LF 128*8 46NM	KN.1GB0F.005
	MEMORY TRANSCEND DDR3 1333MH 1G UNB-DIMM JM1333KLU-1G	KN.1GB0H.015
	MEMORY UNIFOSA DDR3 1333MHZ 1G UNB-DIMM GU502203EP0201 LF 128*8 0.065UM	KN.1GB0C.008

Category	Part Name	Part Number
Memory (continuation)		
	MEMORY APACER DDR3 1333MHZ 2G UNB-DIMM LF 128*8 0.065UM	KN.2GB0B.024
	MEMORY KINGSTON DDR3 1333MHZ 2G UNB ACR256X64D3U1333C9	KN.2GB01.025
	MEMORY SAMSUNG DDR3 1333MHZ 2G M378B5673FH0-CH9	KN.2GB0F.004
	MEMORY TRANSCEND DDR3 1333MHZ 2G UNB-DIMM JM1333KLU-2G	KN.2GB0H.009
	MEMORY UNIFOSA DDR3 1333MHZ 2G UNB-DIMM GU512303EP0202 LF 128*8 0.065UM	KN.2GB07.002
Hard drive		
	HDD 320GB 3.5" 7200RPM SATA II 8MB HGST HDT721032SLA380 SATURN	KH.32008.016
	HDD 320GB 3.5" 7200RPM SATA II SEAGATE PHARAOH 8MB NCQ	KH.32007.006
	HDD 320GB 3.5" 7200RPM SATA II WD WD3200AAJS-22L7A0 XL320S	KH.32001.015
	HDD 3.5" 500GB 7200RPM SATA WD XL320M WD5000AAKS-22M9A0	KH.50008.014
	HDD 640GB 3.5" 7200RPM HGST HDT721064SLA360 SATURN SATA	KH.64001.002
	HDD 640GB 3.5" 7200RPM SATA II WD WD6400AAKS-22A7B2 XL320-M	KH.64007.001
	HDD 640GB 3.5" 7200RPM SEAGATE ST3640623AS BRINKS SATA II 16MB LF	KH.64008.003
	HDD 1TB 3.5" 5400RPM SATAII WD10EADS-22M4B0 8MB GP	KH.01K08.005
	HDD 1TB 3.5" 7200RPM SATA HGST SATURN HDT721010SLA360	KH.01K01.007
	HDD 1TB 3.5" 7200RPM WD XL333M SATA WD1001FALS-22J7B0	KH.01K07.002
	HDD 3.5" 1000GB 7200RPM SATA SEAGATE SEAGATE ST31000528AS LF	KH.01K08.004
	HDD 1.5TB 3.5" 5400RPM SATA WD GP500 WD15EADS-22P8B0 32MB GP	KH.15K08.001
	HDD 1.5TB 3.5" 7200RPM SATA SEAGATE BRINKS ST31500341AS 32MB CC4H 7	KH.15K01.002
Optical drive		
	ODD HLDS BD COMBO 12.7MM TRAY DL 4X CT21N LF W/O BEZEL 1.00 SATA FOR HF+WINDOWS7	KO.00407.004
	ODD PANASONIC BD COMBO 12.7MM TRAY DL 4X UJ141AL LF W/O BEZEL SATA FOR HF+WINDOWS7	KO.0040D.004
	ODD PANASONIC BD RW 12.7MM TRLY DL4 4X UJ240A SATA	KU.00407.015
	ODD HLDS SUPER-MULTI DRIVE 12.7MM TRAY DL 8X GT31N LF W/O BEZEL SATA FOR HF+WINDOWS7	KU.0080D.054
	ODD HLDS SUPER-MULTI DRIVE 12.7MM TRAY DL 8X GT31N LF W/O BEZEL SATA FOR HF+WINDOWS7	KU.0080F.014
	ODD PLDS SUPER-MULTI DRIVE 12.7MM TRAY PLDS DS-8A5SH LF W/O BEZEL SATA FOR HF+WINDOWS7	KU.0080D.054

Category	Part Name	Part Number
LCD panel		
	CCFL LCD LPL 23" WFHD NONE GLARE LM230WF1 TLA5 LF 300NIT 5MS G8	LK.23006.015
	CCFL LCD SAMSUNG 23" WFHD NONE GLARE LTM230HT01 A09 LF 300NIT 5MS 1000:1 HF	LK.23008.009
	CCFL LCD SAMSUNG 23" WFHD NONE GLARE LTM230HT01 A10 LF 300NIT 5MS 1000:1 HF	LK.23006.014
	TOUCH PANEL 23" ETURBO SR-230M182235D1 23" RESISTIVE MUTI-TOUCH PANEL TOUCH FILM	PC.14600.001
Cables		
HDD SATA cable		
	HDD SATA CABLE	50.SAS01.001
	HDD SATA CABLE 15PIN	50.3CM12.001
	HDD SATA CABLE 15PIN	50.3CM30.001
ODD SATA cable	ODD CABLE SATA 7+6PIN	50.3CM13.001
	ODD CABLE SATA 7+6PIN	50.3CM31.001
Power button/LED cable	POWER LED CABLE	50.3CM01.001
	POWER LED CABLE	50.3CM20.001
USB/audio board cable	USB BOARD CABLE	50.3CM03.001
	USB BOARD CABLE	50.3CM22.001
Capacitive LED board cable	FUNCTION KEY CABLE	50.3CM10.001
	FUNCTION KEY CABLE	50.3CM29.001
Inverter cable	INVERTER CABLE 23" WXGA	50.3CM08.001
	INVERTER CABLE 23" WXGA	50.3CM27.001
Light bar cable	LIGHT BAR CABLE	50.3CM09.001
	LIGHT BAR CABLE	50.3CM28.001
Speaker cable	SPEAKER CABLE	50.3CM07.001
	SPEAKER CABLE	50.3CM26.001
Webcam cable	CAMERA CABLE	50.3CM06.001
	CAMERA CABLE	50.3CM25.001
Microphone cable	FIO MIC CABLE	50.3CM02.001
	FIO MIC CABLE	50.3CM21.001
Bluetooth cable	BLUETOOTH CABLE	50.3CM11.001
	BLUETOOTH CABLE	50.3CM15.001
Wireless LAN cable	WIRELESS CR CABLE	50.3CM04.001
	WIRELESS CR CABLE	50.3CM23.001
USB Bluetooth cable	USB CABLE	50.3CM05.001
	USB CABLE	50.3CM24.001

Category	Part Name	Part Number
Power supply unit		
	POWER SUPPLY 220W CHICONYPower EPA CPB09-D220E AAGASSI	PY.22009.008
	POWER SUPPLY 220W CHICONYPower PFC CPB09-D220A AAGASSI	PY.2200B.007
	POWER SUPPLY 220W CHICONYPower REGULAR CPB09-D220R AAGASSI	PY.22009.006
	POWER SUPPLY 220W EUP 115VAC/230V NPFC DELTA DPS-220UB A EUP	PY.2200B.006
	POWER SUPPLY 220W FULL EPS5.0 DELTA DPS-220UB-2 B EUP	PY.2200B.008
	POWER SUPPLY 220W LITE-ON FULL PS-5221-9AE-ROHS 8.5L EUP 82+	PY.2200F.005
	POWER SUPPLY 220W NPFC 115V/230V LITEON PS-5221-06A1-ROHS EUP	PY.22009.007
	POWER SUPPLY 220W PFC 230V DELTA DPS-220UB-1 A EUP	PY.2200F.006
	POWER SUPPLY 220W PFC 230V LITEON PE-5221-08AP-ROHS EUP	PY.2200F.004
AC power cord	POWER CORD 250V SOUTH AFRICA	27.01518.0Q1
Keyboard		
	KEYBOARD RF2.4 105 KEY CHICONY WUG0570 105KS BLACK NORWEGIAN WITH PB LOGO	KB.RF403.195
	KEYBOARD RF2.4 105 KEY CHICONY WUG0570 BLACK ARABIC/ENGLISH	KB.RF403.212
	KEYBOARD RF2.4 105 KEY CHICONY WUG0570 BLACK BELGIUM WITH PB LOGO	KB.RF403.193
	KEYBOARD RF2.4 105 KEY CHICONY WUG0570 BLACK CZECH WITH PB LOGO	KB.RF403.204
	KEYBOARD RF2.4 105 KEY CHICONY WUG0570 BLACK DANISH WITH PB LOGO	KB.RF403.203
	KEYBOARD RF2.4 105 KEY CHICONY WUG0570 BLACK DUTCH WITH PB LOGO	KB.RF403.191
	KEYBOARD RF2.4 105 KEY CHICONY WUG0570 BLACK FRENCH WITH PB LOGO	KB.RF403.208
	KEYBOARD RF2.4 105 KEY CHICONY WUG0570 BLACK GERMAN WITH PB LOGO	KB.RF403.209
	KEYBOARD RF2.4 105 KEY CHICONY WUG0570 BLACK GREEK WITH PB LOGO	KB.RF403.202
	KEYBOARD RF2.4 105 KEY CHICONY WUG0570 BLACK HEBREW WITH PB LOGO	KB.RF403.196
	KEYBOARD RF2.4 105 KEY CHICONY WUG0570 BLACK HUNGARIAN WITH PB LOGO	KB.RF403.201
	KEYBOARD RF2.4 105 KEY CHICONY WUG0570 BLACK ICELANDIC WITH PB LOGO	KB.RF403.194
	KEYBOARD RF2.4 105 KEY CHICONY WUG0570 BLACK ITALIAN WITH PB LOGO	KB.RF403.189
	KEYBOARD RF2.4 105 KEY CHICONY WUG0570 BLACK NORDIC WITH PB LOGO	KB.RF403.210
	KEYBOARD RF2.4 105 KEY CHICONY WUG0570 BLACK POLISH WITH PB LOGO	KB.RF403.197

Category	Part Name	Part Number
Keyboard (continuation)		
	KEYBOARD RF2.4 105 KEY CHICONY WUG0570 BLACK PORTUGUESE WITH PB LOGO	KB.RF403.188
	KEYBOARD RF2.4 105 KEY CHICONY WUG0570 BLACK ROMANIAN WITH PB LOGO	KB.RF403.205
	KEYBOARD RF2.4 105 KEY CHICONY WUG0570 BLACK RUSSIAN WITH PB LOGO	KB.RF403.200
	KEYBOARD RF2.4 105 KEY CHICONY WUG0570 BLACK SLOVAK WITH PB LOGO	KB.RF403.199
	KEYBOARD RF2.4 105 KEY CHICONY WUG0570 BLACK SLOVENIAN WITH PB LOGO	KB.RF403.198
	KEYBOARD RF2.4 105 KEY CHICONY WUG0570 BLACK SPANISH WITH PB LOGO	KB.RF403.187
	KEYBOARD RF2.4 105 KEY CHICONY WUG0570 BLACK SWEDISH WITH PB LOGO	KB.RF403.190
	KEYBOARD RF2.4 105 KEY CHICONY WUG0570 BLACK SWISS/G WITH PB LOGO	KB.RF403.192
	KEYBOARD RF2.4 105 KEY CHICONY WUG0570 BLACK TURKISH WITH PB LOGO	KB.RF403.206
	KEYBOARD RF2.4 105 KEY CHICONY WUG0570 BLACK UK WITH PB LOGO	KB.RF403.207
	KEYBOARD RF2.4 105 KEY CHICONY WUG0570 BLACK US INTERNATIONAL WITH PB LOGO	KB.RF403.186
	KEYBOARD USB 105 KEY CHICONY BLACK UK	KB.USB03.268
	KEYBOARD USB 105 KEY CHICONY KU-0420 BLACK BELGIUM	KB.USB03.254
	KEYBOARD USB 105 KEY CHICONY KU-0420 BLACK CZECH	KB.USB03.265
	KEYBOARD USB 105 KEY CHICONY KU-0420 BLACK DANISH	KB.USB03.264
	KEYBOARD USB 105 KEY CHICONY KU-0420 BLACK DUTCH	KB.USB03.252
	KEYBOARD USB 105 KEY CHICONY KU-0420 BLACK FRENCH	KB.USB03.269
	KEYBOARD USB 105 KEY CHICONY KU-0420 BLACK GERMAN	KB.USB03.270
	KEYBOARD USB 105 KEY CHICONY KU-0420 BLACK GREEK	KB.USB03.263
	KEYBOARD USB 105 KEY CHICONY KU-0420 BLACK HEBREW	KB.USB03.257
	KEYBOARD USB 105 KEY CHICONY KU-0420 BLACK HUNGARIAN	KB.USB03.262
	KEYBOARD USB 105 KEY CHICONY KU-0420 BLACK ICELANDIC	KB.USB03.255
	KEYBOARD USB 105 KEY CHICONY KU-0420 BLACK ITALIAN	KB.USB03.250
	KEYBOARD USB 105 KEY CHICONY KU-0420 BLACK NORDIC	KB.USB03.271
	KEYBOARD USB 105 KEY CHICONY KU-0420 BLACK POLISH	KB.USB03.258

Category	Part Name	Part Number
Keyboard (continuation)		
	KEYBOARD USB 105 KEY CHICONY KU-0420 BLACK PORTUGUESE	KB.USB03.249
	KEYBOARD USB 105 KEY CHICONY KU-0420 BLACK ROMANIAN	KB.USB03.266
	KEYBOARD USB 105 KEY CHICONY KU-0420 BLACK RUSSIAN	KB.USB03.261
	KEYBOARD USB 105 KEY CHICONY KU-0420 BLACK SLOVAK	KB.USB03.260
	KEYBOARD USB 105 KEY CHICONY KU-0420 BLACK SLOVENIAN	KB.USB03.259
	KEYBOARD USB 105 KEY CHICONY KU-0420 BLACK SPANISH	KB.USB03.248
	KEYBOARD USB 105 KEY CHICONY KU-0420 BLACK SWISS/G	KB.USB03.253
	KEYBOARD USB 105 KEY CHICONY KU-0420 BLACK TURKISH	KB.USB03.267
	KEYBOARD USB 105 KEY CHICONY KU-0420 BLACK US INTERNATIONAL	KB.USB03.247
	KEYBOARD USB 105 KEY CHICONY KU-0420 STANDARD BLACK ARABIC/ENGLISH	KB.USB03.272
	KEYBOARD USB 105 KEY CHICONY KU-0420 USB BLACK SWEDISH	KB.USB03.251
	KEYBOARD USB 105 KEY CHICONY KU-0420 USB NORWEGIAN	KB.USB03.256
Mouse	MOUSE RF2.4 CHICONY MG-0570T W	MS.11200.062
	MOUSE USB CHICONY MSU0960T-E93L	MS.11200.061
Screws	SCREW I NO6-32 L5 BZN	86.00J07.B60
	SCREW NO4-40 L6.5 PAN NI	86.00N03.B40
	SCREW PAN #6-32 L6 NI BOXER WZS	86.00J44.C60
Accessories		
USB dongle receiver	RECEIVER CHICONY DANGLE RECEIVER USB EXTERNAL	RV.11000.022
Remote control	REMOTE CONTROL PHILIPS RC2604301/01B MSFT CODE PAIR WITH OVU430008 EMEA FOR WINDOWS7	RT.11300.023
	REMOTE CONTROL PHILIPS RC2604302/01B MSFT CODE PAIR WITH OVU430008 US FOR WINDOWS7	RT.11300.022
	REMOTE CONTROL PHILIPS RC2604307/01BG PAIR WITH RV.11000.007 EMEA FOR WINDOWS7	RT.11300.021
	REMOTE CONTROL SMK RRS9003-3406E QUATRO PULSE US WITH BATTERY PACK FOR WINDOWS7	RT.11300.025
	REMOTE CONTROLLER PHILIPS RC2604701/01B MSFT CODE JAPAN; PAIR WITH OVU430005 WINDOWS7	RT.11300.024
FRU items for part number updating		
FRONT BOARD	PGREENWOOD -1 FRONT BOARD DIP MP	TBD
LIGHT BAR BOARD	PGREENWOOD -1 LIGHT BAR BOARD DIP MP	TBD
RISER BOARD FOR SHORT VGA	PGREENWOOD -1 RISER FOR SHORT VGA DIP MP	TBD
SCALER BOARD	PGREENWOOD -1 SCALER BOARD DIP MP	TBD
DVI TO D-SUB CABLE	C.A. DVI TO D-SUB CABLE DTX_AIO	TBD

Category	Part Name	Part Number
HDMI CABLE 600MM	C.A. HDMI 600MM CABLE DTX AIO	TBD
LVDS CABLE 23	"C.A LVDS CABLE 21_5 PG	TBD
ASSY MB COVER BRACKET PG	ASSY MB COVER BRACKET PG	TBD
BACK COVER FOR 23	"ASSY BACK COVER PG	TBD
FRONT BEZEL FOR 23	"ASSY FRONT BEZEL 23 PG	TBD
FRONT IO BOARD BRACKET	ASSY FRONT IO BRACKET PG	TBD
FUNCTION KEY COVER	CVR FUNCTION KEY COVER PG	TBD
HDD BRACKET	BRKT HDD BKT PG	TBD
HLDR POWER HOLDER PG	HLDR POWER HOLDER PG	TBD
INVERTER BOARD COVER	ASSY INVERTER COVER BKT PG	TBD
MAIN CHASSIS FOR GREENWOOD	ASSY MAIN CHASSIS PG	TBD
ODD BEZEL	ASSY ODD BEZEL RW PG	TBD
ODD BRACKET	BRKT ODD BRACKET PG	TBD
POWER SUPPLY BRACKET	BRKT PSU HOLDER BKT PG	TBD
RISER CARD BRACKET	BRKT RISER BKT PG	TBD
SCALAR COVER BRACKET	BRKT SCALAR COVER BKT PG	TBD
WIRE COVER	CVR WIRE COVER PG	TBD
WIRE HOLDER	HLDR WIRE HOLDER PG	TBD
ANTENNA AUX WLAN GALLAGHER ACON	ANTENNA AUX WLAN GALLAGHER ACON	TBD
ANTENNA MAIN WLAN GALLAGHER ACON	ANTENNA MAIN WLAN GALLAGHER ACON	TBD
ASSEMBLY HINGE MODULE FOOT STAND	ASSY HINGE MODULE PG	TBD
ASSEMBLY LCD MODULE 23" WFHD NONE GLARE SAMSUNG W/TOUCH PANEL&CONTRAL BOARD& GLUE	ASSY LCD 23" SAMSUNG W/TP&BD	TBD
GLUE FOR GLASS PANEL LEFT AND RIGHT 23	"GLUE GLASS PANEL L-R 23 PG	TBD

Model Definitions and Configurations

This chapter provides features summary for each of the Packard Bell oneTwo M3350 / oneTwo M3351 / oneTwo L5350 / oneTwo L5351 computer model configurations.

Packard Bell oneTwo M3351 / oneTwo L5351 Model Configuration

Common features

- Project name: gGreenwood
- DIMM1: U2GBII13
- Mainboard: Greenwood
- Card reader: Yes
- WNMCP78PV_1394(N)_LOGO(N)_Eup(Y)

Model	Part No.	Description	Chassis	Bezel	CPU	DIMM2	DIMM3	HDD	ODD	LCD	VGA	TV Tuner	Add-on Card 1	Add-on Card 2	Keyboard	Mouse	Remote Control	PSU	Power Cord	OS
oTL5351	PW.U5RE2.001	oTL5351 CH EMEA001 W7HP64PFR0206/ATHIIX2215/2G*2/500G*1/NSM8XS/B23/315/802.11 b/g/n/KB/mouse	HX0931	PAIO1023	ATHIIX2 215	U2GBII I13	N	D500GB7 .2KS	NSM8XS	D23FHD	Nvidia 315 512MB HDMI/DVI LP	N	802.11 b/g/n (mini-card/USB)(half size) Kit	N	N	USB/0420_PB	USB/0420	PFC 220W (8.5L) EuP	EU	W7HP64
oTL5351	PW.U5RE2.002	oTL5351 CH EMEA001 W7HP64PFR0206/ATHIIX2215/2G*2/640G*1/NSM8XS/B23/GT320/H753-D Kit/802.11 b/g/n/ EMEA Win7 WMC/KB/mouse	HX0931	PAIO1023	ATHIIX2 215	U2GBII I13	N	D640GB7 .2KS	NSM8XS	D23FHD	Nvidia GT320 1GB HDMI/DVI LP	PCIe/SW/ DVB-T/ DTXAIO_Kit	802.11 b/g/n (mini-card/USB)(half size) Kit	N	EMEA Win7 WMC	USB/0420_PB	USB/0420	PFC 220W (8.5L) EuP	EU	W7HP64
oTL5351	PW.U5RE2.009	oTL5351 CH EMEA001 W7HP64RUPRU4407 /ATHIIX4605e/2G*2/500G*1/NSM8XS/B23/GT320/802.11 b/g/n/KB/RF2.4/0420_PB	HX0931	PAIO1023	ATHIIX4 605e	U2GBII I13	N	D500GB7 .2KS	NSM8XS	D23FHD	Nvidia GT320 1GB HDMI/DVI LP	N	802.11 b/g/n (mini-card/USB)(half size) Kit	N	N	RF2.4/0420_PB	RF2.4/0420_PB	PFC 220W (8.5L) EuP	EU	W7HP64RU
oTL5351	PW.U5RE2.015	oTL5351 CH EMEA001 W7HP64PDE0307/ATHIIX2240/2G*2/500G*1/NSM8XS/B23/HD5450/H753-D Kit/802.11 b/g/n/ EMEA Win7 WMC/KB/RF2.4/0420_PB	HX0931	PAIO1023	ATHIIX2 240	U2GBII I13	N	D500GB7 .2KS	NSM8XS	D23FHD	ATI HD5450 512MB HDMI/DVI LP	PCIe/SW/ DVB-T/ DTXAIO_Kit	802.11 b/g/n (mini-card/USB)(half size) Kit	N	EMEA Win7 WMC	RF2.4/0420_PB	RF2.4/0420_PB	PFC 220W (8.5L) EuP	EU	W7HP64
oTL5351	PW.U5RE2.017	oTL5351 CH EMEA001 W7HP64PNO9105/ATHIIX4605e/2G*2/1000G*1/NSM8XS/B23/HD5570/802.11 b/g/n/KB/RF2.4/0420_PB	HX0931	PAIO1023	ATHIIX4 605e	U2GBII I13	N	D1000GB 5.4KS	NSM8XS	D23FHD	ATI HD5570 1GB HDMI/DVI LP	N	802.11 b/g/n (mini-card/USB)(half size) Kit	N	N	RF2.4/0420_PB	RF2.4/0420_PB	PFC 220W (8.5L) EuP	EU	W7HP64
oTL5351	PW.U5RE2.036	oTL5351 CH EMEA001 W7HP64RUPRU4407 /ATHIIX4605e/2G*2/500G*1/NSM8XS/B23/HD5570/802.11 b/g/n/KB/RF2.4/0420_PB	HX0931	PAIO1023	ATHIIX4 605e	U2GBII I13	N	D500GB7 .2KS	NSM8XS	D23FHD	ATI HD5570 1GB HDMI/DVI LP	N	802.11 b/g/n (mini-card/USB)(half size) Kit	N	N	RF2.4/0420_PB	RF2.4/0420_PB	PFC 220W (8.5L) EuP	EU	W7HP64RU

Model	Part No.	Description	Chassis	Bezel	CPU	DIMM2	DIMM3	HDD	ODD	LCD	VGA	TV Tuner	Add-on Card 1	Add-on Card 2	Keyboard	Mouse	Remote Control	PSU	Power Cord	OS
oTL5351	S1.U5R02.001	oTL5351 Sample EMEA001 W7HP64PIT0604/ PHNMI1705e/2G*2/ 640G*1/NBDRW4XS/ B23/EMEA Win7/ Philips/PS2/1688/ PS2Opt/PB	HX093I	PAIO1023	PHNMI1705e	N	U2GBII I13	D640GB7 .2KS	NBDRW4 XS	D23FHD	N	N	N	N	EMEA Win7/ Philips	PS2/1688	PS2Opt/ PB	PFC 220W (8.5L) EuP	EU	W7HP64
oTM3351	PW.U5PE2 .001	oTM3351 CH EMEA001 W7HP64PUK0108/ ATHIX2250/ 1G*1+2G*1/320G*1/ NSM8XS/D21.5H/ H753-D Kit/802.11 b/ g/n/EMEA Win7 WMC/KB/RF2.4/ 0420_PB	HX093J	PAIO1021	ATHIX2 250	U2GBII I13	N	D320GB7 .2KS	NSM8XS	D21.5WU XGA	N	PCIe/SW/ DVB-T/ DTXAIO_Kit	802.11 b/g/ n (mini-card/ USB)(half size) Kit	N	EMEA Win7 WMC	RF2.4/ 0420_PB	RF2.4/ 0420_PB	PFC 220W (8.5L) EuP	UK	W7HP64
oTM3351	PW.U5PE2 .002	oTM3351 CH EMEA001 W7HP64PFR0206/ SMP140/2G*1/ 320G*1/NSM8XS/ D21.5H/802.11 b/g/n/ KB/mouse	HX093J	PAIO1021	SMP140	N	N	D320GB7 .2KS	NSM8XS	D21.5WU XGA	N	N	802.11 b/g/ n (mini-card/ USB)(half size) Kit	N	N	USB/ 0420_PB	USB/0420	PFC 220W (8.5L) EuP	EU	W7HP64
oTM3351	PW.U5PE2 .003	oTM3351 CH EMEA001 W7HP64PFR0206/ ATHIX2215/ 2G*1+1G*1/500G*1/ NSM8XS/D21.5H/ 802.11 b/g/n/KB/ mouse	HX093J	PAIO1021	ATHIX2 215	U1GBII I13	N	D500GB7 .2KS	NSM8XS	D21.5WU XGA	N	N	802.11 b/g/ n (mini-card/ USB)(half size) Kit	N	N	USB/ 0420_PB	USB/0420	PFC 220W (8.5L) EuP	EU	W7HP64
oTM3351	PW.U5PE2 .049	oTM3351 CH EMEA001 W7HP64PES0407/ ATHIX2215/2G*2/ 1000G*1/NSM8XS/ D21.5H/315/H753-D Kit/802.11 b/g/n/ Bluetooth/EMEA Win7 WMC/KB/RF2.4/ 0420_PB	HX093J	PAIO1021	ATHIX2 215	U2GBII I13	N	D1000GB 5.4KS	NSM8XS	D21.5WU XGA	Nvidia 315 512MB HDMI/DVI LP	PCIe/SW/ DVB-T/ DTXAIO_Kit	802.11 b/g/ n (mini-card/ USB)(half size) Kit	Bluetooth Kit	EMEA Win7 WMC	RF2.4/ 0420_PB	RF2.4/ 0420_PB	PFC 220W (8.5L) EuP	EU	W7HP64
oTM3351	PW.U5PE2 .050	oTM3351 CH EMEA001 W7HP64PPOR1003/ ATHIX2215/2G*2/ 1000G*1/NSM8XS/ D21.5H/315/H753-D Kit/802.11 b/g/n/ Bluetooth/EMEA Win7 WMC/KB/RF2.4/ 0420_PB	HX093J	PAIO1021	ATHIX2 215	U2GBII I13	N	D1000GB 5.4KS	NSM8XS	D21.5WU XGA	Nvidia 315 512MB HDMI/DVI LP	PCIe/SW/ DVB-T/ DTXAIO_Kit	802.11 b/g/ n (mini-card/ USB)(half size) Kit	Bluetooth Kit	EMEA Win7 WMC	RF2.4/ 0420_PB	RF2.4/ 0420_PB	PFC 220W (8.5L) EuP	EU	W7HP64
oTM3351	PW.U5PE2 .176	oTM3351 CH EMEA001 W7HP64PCHB106/ ATHIX2215/2G*2/ 500G*1/NSM8XS/ D21.5H/H753-D Kit/ EMEA Win7 WMC/ KB/mouse	HX093J	PAIO1021	ATHIX2 215	U2GBII I13	N	D500GB7 .2KS	NSM8XS	D21.5WU XGA	N	PCIe/SW/ DVB-T/ DTXAIO_Kit	N	N	EMEA Win7 WMC	USB/ 0420_PB	USB/0420	PFC 220W (8.5L) EuP	Swiss/EU	W7HP64

Model	Part No.	Description	Chassis	Bezel	CPU	DIMM2	DIMM3	HDD	ODD	LCD	VGA	TV Tuner	Add-on Card 1	Add-on Card 2	Keyboard	Mouse	Remote Control	PSU	Power Cord	OS
oTM3351	PW.U5PE2 .177	oTM3351 CH EMEA001 W7HP64PFR0206/ATHIIX2215/2G*1+1G*1/500G*1/NSM8XS/D21.5H/KB/mouse	HX093J	PAIO1021	ATHIIX2 215	U1GBII I13	N	D500GB7 .2KS	NSM8XS	D21.5WU XGA	N	N	N	N	N	USB/0420_PB	USB/0420	PFC 220W (8.5L) EuP	EU	W7HP64
oTM3351	PW.U5PE2 .178	oTM3351 CH EMEA001 W7HP64PFR0206/ATHIIX2215/2G*2/640G*1/NSM8XS/D21.5H/802.11 b/g/n/KB/mouse	HX093J	PAIO1021	ATHIIX2 215	U2GBII I13	N	D640GB7 .2KS	NSM8XS	D21.5WU XGA	N	N	802.11 b/g/n (mini-card/USB)(half size) Kit	N	N	USB/0420_PB	USB/0420	PFC 220W (8.5L) EuP	EU	W7HP64
oTM3351	PW.U5PE2 .180	oTM3351 CH EMEA001 W7HP64RUPRU4407/ATHIIX4600e/2G*2/500G*1/NSM8XS/D21.5H/GT320/802.11 b/g/n/KB/RF2.4/0420_PB	HX093J	PAIO1021	ATHIIX4 600e	U2GBII I13	N	D500GB7 .2KS	NSM8XS	D21.5WU XGA	Nvidia GT320 1GB HDM/DVI LP	N	802.11 b/g/n (mini-card/USB)(half size) Kit	N	N	RF2.4/0420_PB	RF2.4/0420_PB	PFC 220W (8.5L) EuP	EU	W7HP64R U
oTM3351	PW.U5PE2 .181	oTM3351 CH EMEA001 W7HP64PNO9105/ATHIIX2215/2G*1+1G*1/500G*1/NSM8XS/D21.5H/802.11 b/g/n/KB/mouse	HX093J	PAIO1021	ATHIIX2 215	U1GBII I13	N	D500GB7 .2KS	NSM8XS	D21.5WU XGA	N	N	802.11 b/g/n (mini-card/USB)(half size) Kit	N	N	USB/0420_PB	USB/0420	PFC 220W (8.5L) EuP	EU	W7HP64
oTM3351	PW.U5PE2 .186	oTM3351 CH EMEA001 W7HP64PFR0206/ATHIIX2215/2G*1+1G*1/320G*1/NSM8XS/D21.5H/H753-D Kit/802.11 b/g/n/EMEA Win7 WMC/KB/mouse	HX093J	PAIO1021	ATHIIX2 215	U1GBII I13	N	D320GB7 .2KS	NSM8XS	D21.5WU XGA	N	PCIe/SW/DVB-T/DTXAIO_Kit	802.11 b/g/n (mini-card/USB)(half size) Kit	N	EMEA Win7 WMC	USB/0420_PB	USB/0420	PFC 220W (8.5L) EuP	EU	W7HP64
oTM3351	PW.U5PE2 .188	oTM3351 CH EMEA001 W7HP64PDE0307/ATHIIX2240/2G*2/500G*1/NSM8XS/D21.5H/KB/mouse	HX093J	PAIO1021	ATHIIX2 240	U2GBII I13	N	D500GB7 .2KS	NSM8XS	D21.5WU XGA	N	N	N	N	N	USB/0420_PB	USB/0420	PFC 220W (8.5L) EuP	EU	W7HP64
oTM3351	PW.U5PE2 .190	oTM3351 CH EMEA001 W7HP64PNO9105/ATHIIX2215/2G*1+1G*1/500G*1/NSM8XS/D21.5H/HD5450/802.11 b/g/n/KB/mouse	HX093J	PAIO1021	ATHIIX2 215	U1GBII I13	N	D500GB7 .2KS	NSM8XS	D21.5WU XGA	ATI HD5450 512MB HDM/DVI LP	N	802.11 b/g/n (mini-card/USB)(half size) Kit	N	N	USB/0420_PB	USB/0420	PFC 220W (8.5L) EuP	EU	W7HP64
oTM3351	PW.U5PE2 .192	oTM3351 CH EMEA001 W7HP64PBEA703/ATHIIX2215/2G*2/500G*1/NSM8XS/D21.5H/315/H753-D Kit/802.11 b/g/n/EMEA Win7 WMC/KB/RF2.4/0420_PB	HX093J	PAIO1021	ATHIIX2 215	U2GBII I13	N	D500GB7 .2KS	NSM8XS	D21.5WU XGA	Nvidia 315 512MB HDM/DVI LP	PCIe/SW/DVB-T/DTXAIO_Kit	802.11 b/g/n (mini-card/USB)(half size) Kit	N	EMEA Win7 WMC	RF2.4/0420_PB	RF2.4/0420_PB	PFC 220W (8.5L) EuP	EU	W7HP64

Model	Part No.	Description	Chassis	Bezel	CPU	DIMM2	DIMM3	HDD	ODD	LCD	VGA	TV Tuner	Add-on Card 1	Add-on Card 2	Keyboard	Mouse	Remote Control	PSU	Power Cord	OS
oTM3351	PW.U5PE2.201	oTM3351 CH EMEA001 W7HP64RUPRU4407 /ATHIIX3405e/ 2G*1+1G*1/320G*1/ NSM8XS/D21.5H/ HD5450/802.11 b/g/n/ KB/RF2.4/0420_PB	HX093J	PAIO1021	ATHIIX3 405e	U1GBII 113	N	D320GB7 .2KS	NSM8XS	D21.5WU XGA	ATI HD5450 512MB HDM/DVI LP	N	802.11 b/g/n (mini-card/USB)(half size) Kit	N	N	RF2.4/0420_PB	RF2.4/0420_PB	PFC 220W (8.5L) EuP	EU	W7HP64RU
oTM3351	S1.U5P02.001	oTM3351 Sample EMEA001 W7HP64PNO9105/ PHNMII705e/2G*2/ 640G*1/NSM8XS/ D21.5H/802.11 b/g/n/ KB/mouse	HX093J	PAIO1021	PHNMII 705e	U2GBII 113	N	D640GB7 .2KS	NSM8XS	D21.5WU XGA	N	N	802.11 b/g/n (mini-card/USB)(half size)	N	N	USB/0420_PB	USB/0420	PFC 220W (8.5L) EuP	EU	W7HP64



Test Compatible Components

This computer's compatibility is tested and verified by Acer's internal testing department. All of its system functions are tested for both the Home Basic and Home Premium editions of Microsoft's Windows Vista operating system.

Refer to the following lists for components, adapter cards, and peripherals which have passed these tests. Regarding configuration, combination and test procedures, please refer to the Packard Bell oneTwo M3350 / oneTwo M3351 / oneTwo L5350 / oneTwo L5351 Vista Compatibility Test Report released by the Acer Mobile System Testing Department.

Item	Device Name	Vendor
Access Point	Air Station Wireless NFINITI [Model Num: WZR-G144N], 802.11n/g/b	Buffalo
	Buffalo Air Station NFINITI [ModeNum:WZR2-G300N], 802.11n/g/b	Buffalo
Bluetooth Access Point	Bluetooth Access Point [ModeNum:BT300]	X Bridge
Bluetooth Devices	Bluetooth Stereo Headset [ModeNum:HT820]	Motorola
	Bluetooth Mouse [ModeNum:097855020512]	Logitech
	Motorola Bluetooth Wireless Headset H300	Motorola
	Sony Ericsson Stereo Bluetooth Headset HBH-DS970	Sony
External LCD	P243W 24-inch LCD Monitor	Acer
	P244W 24-inch LCD Monitor	Acer
	SP2208WFP 22-inch LCD Monitor	Dell
	UltraSharp 3008WFP 30-inch LCD Monitor	Dell
	2407FPW 24-inch LCD Monitor	Dell
	UltraSharp E2408WFP 24-inch Widescreen HDMI	Dell
Earphone / Microphone	Hawk Stereo Headset 933	Hawk
Projector	3300MP Projector	Dell
SIM Card	FarEasTone 3G SIM Card	FarEasTone
	Chunghwa Telecom 3G SIM Card	Chunghwa Telecom
TV	W37G (HDMI)	Westinghouse
	TC-37MPK (VGA/HDMI)	Panasonic
USB 3G Card	Huawei Mobile Connect E220 USB Modem 3G (E220: HSDPA/UMTS/EDGE/GPRS/GSM)	Huawei
USB Camera	Canon Digital IXUS 860 IS Digital Compact Camera (8.0 MP CCD sensor/DIGIC III with Face Detection AF/AE/FE/28mm wide-angle lens with optical Image Stabilizer, Media storage: SD, SDHC, MMC, MMCplus, built-in SD 32 MB)	Canon
USB Storage Drive	6-in-1 Flash Card Reader/Writer	PQI

Item	Device Name	Vendor
USB Flash Drive	Transcend JetFlash USB 2.0 Flash Drive V85 8 GB Memory Key	Transcend
	Apacer AH421 8 GB	Apacer
	A-Data PD16 Vista 16 GB	A-Data
	Transcend JetFlash USB 2.0 Flash Drive V10 16 GB Memory Key	Transcend
USB HDD	2.5-inch Portable 80 GB Hard Disk	Transcend
USB ODD	DVD+R/RW (USB 2.0)	Plextor
USB Hub and Others	Huawei Mobile Connect E220 USB Modem 3G (E220: HSDPA/UMTS/EDGE/GPRS/GSM)	Huawei
	PowerSync USB2.0 4-Port Mini Hub (HU151W White)	PowerSync
	Techworks 4-Port USB2.0 Mini Hub (OW4PTUSBHB)	Techworks
USB Keyboard/ Mouse	First Wheel Mouse	Logitech
	Internet Navigator Keyboard	Logitech
	Dell L30U 0N242F USB Keyboard	Dell
USB Printer	HP Deskjet F4280 All-in-One: Printer/ Scanner/Copier, 1200x2400 dpi)	HP
USB Speaker/ Joystick	iFun USB Speaker (JS1200UA)	JS
	Dell USB Speaker	Dell
Wireless Printer	Photosmart C309 (CC35A) All-in-One Printer (4x6 photos/CD/DVD/Quick Forms, /Scanner/Copier/Fax) Port: USB2.0/Ethernet/PictBridge/802.11g/BT	HP
	Photosmart C4580 All-in-One Printer (4x6 photos) / Scanner/Copier Port: USB2.0/802.11g.b/Memory Card	HP
Memory Stick	High Speed 1 GB Memory Stick Pro Duo	Lexar
	MS PRO Dou 2 GB High Speed	Sony
	MS PRO 2 GB Memory Card	Sony
	SanDisk Memory Stick Micro (M2) 8GB Card	SanDisk
Multimedia Card	RS-MMC 128MB Memory Card	SanDisk
	RS-MMC Mobile 256MB Memory Card	PQI
	Transcend MMC plus 4GB Card	Transcend
	Turbo 200X 2GB MMC Card	A-DATA
SD Card	4GB SD PRO Memory Card	RiDATA
	SanDisk Multi-use SD Class 2 Memory Card 2GB	SanDisk
	SD Card 2 GB (150x Hi-Speed)	Apacer
	SanDisk MicroSDHC 4 GB Card with Adapter	SanDisk
	Kingston SDHC SD4 32 GB Card	Kingston
xD Card	Olympus xD-Picture Card M+ 2GB Speed Card	Olympus
	Fujifilm xD-Picture Card Type M 2 GB	Fujifilm

Approved Vendor List (AVL)

Component	Vendor	Description	Model	Part Number
Mainboard kit	Wistron	MB Kit oTM3350/3351_oTL5350/5351 nVidia MCP78PV Proprietary W/O 1394 LF DDRIII 4 DIMM W/ EUP	"Greenwood WNMCP78PV_1394(N)_LOGO(N)_Eup(Y)	MB.U5N01.001
		Mainboard oTM3350/3351_oTL5350/5351 nVidia MCP78PV Proprietary W/O 1394 LF DDRIII 4 DIMM W/ EUP	"Greenwood WNMCP78PV_1394(N)_LOGO(N)_Eup(Y)	MB.U5N01.002
Front bezel	Wistron	Wistron PB Bezel PAIO1021 for 21.5" w/i HX093J chassis	PAIO1021	PZ.11900.196
		Wistron PB Bezel PAIO1023 for 23" w/i HX093I chassis	PAIO1023	PZ.11900.195
Main chassis	Wistron	Wistron(LY) Chassis xSFF HX093I for AIO GAIO_PAIO_1023 Bezel	HX093I	HS.13100.139
		Wistron(LY) Chassis xSFF HX093J for AIO GAIO_PAIO_1021 Bezel	HX093J	HS.13100.140
Heat sink fan	CM	CM iCooler LGA775 AIO DL5-8KDSA-R1-GP w/i pure al 25mm w/i 9225 fan for DTX AIO, 65W		HI.10800.079
Processor	AMD	PhenomII 910e AM3+ 2.6G 4x512K 4000 940 65W C-3 Quad Core	HD910EOCK4DGM	KC.PE202.910
		PhenomII x 4 900e 2.4GHz, 6M total cache 65W, Deneb, PHNMII900e	HD900EOCK4DGI	KC.PE202.900
		PhenomII x 3 705e 2.5GHz, 7.5M total cache 65W, Heka, PHNMII705e	HD705EOCK3DGI	KC.PE202.705
		PhenomII x 3 700e 2.4GHz, 7.5M total cache 65W, Heka, PHNMII700e	HD700EOCK3DGI	KC.PE202.700
		AthlonII 610e AM3+ 2.4G 4x512K 4000 940 45W C-3 Quad Core	AD610EHDK42GM	KC.AM202.610
		AMD Athlon II x4 605e 2.3G 512KB x4(45W)	AD605EHDK42GI	KC.AE202.605
		Athlon II x4 600e 2.2GHz, 2M L2 cache 45W, Propus, ATHIIX4600e	AD600EHDK42GI	KC.AE202.600
		AthlonII 410e AM3+ 2.5G 3x512K 4000 940 45W C-3 Triple Core	AD410EHDK32GM	KC.AM202.410
		Athlon II x3 405e 2.3GHz, 1.5M L2 cache 45W, Rana, ATHIIX3405e	AD405EHDK32GI	KC.AE202.405
		AthlonII 255 AM3+ 2x1M 4000 940 65W C-2 3.1G, Dual Core	ADX255OCK23GM	KC.AM202.255

Component	Vendor	Description	Model	Part Number
		Athlon II x2 250 3.0GHz, 2M L2 cache 65W, Regor, ATHIIX2250	ADX250OCK23GM	KC.AM202.250
		AMD Athlon II x2 245 2.9G 1Mx2 (65W)	ADX245OCK23GQ	KC.AT202.245
		Athlon II x2 240 2.8GHz, 2M L2 cache 65W, Regor, ATHIIX2240	ADX240OCK23GQ	KC.AT202.240
		Athlon II x2 215 2.7GHz 1M L2 cache 65W, Regor, ATHIIX2215	ADX215OCK22GQ	KC.AT202.215
Memory	Unifosa	DDRIII1333	GU502203EP0201 LF 128*8 0.065um	KN.1GB0H.015
		DDRIII1333	GU512303EP0202 LF 128*8 0.065um	KN.2GB0H.009
	Samsung	DDRIII1333	M378B5673FH0-CH9 LF 128*8 46nm	KN.2GB0B.024
		DDRIII1333	M378B2873FHS-CH9 LF 128*8 46nm	KN.1GB0B.036
	Transcend	DDRIII1333	JM1333KLU-1G	KN.1GB0F.005
		DDRIII1333	JM1333KLU-2G	KN.2GB0F.004
	Kingston	DDRIII1333	ACR128X64D3U1333C9 LF 128*8 0.07um	KN.1GB07.002
		DDRIII1333	ACR256X64D3U1333C9 LF 128*8 0.07um	KN.2GB07.002
	Apacer	DDRIII1333	75.073C1.G02 LF 128*8 0.065um	KN.1GB01.031
		DDRIII1333	75.A73C1.G02 LF 128*8 0.065um	KN.2GB01.025
A-data	DDRIII1333	AD6311A0816EZ	KN.1GB0C.008	
Hard drive	HGST	7200rpm 320GB HDT721032SLA380	Saturn	KH.32007.006
		7200rpm 640GB HDT721064SLA360	Saturn	KH.64007.001
		7200rpm 1000GB HDT721010SLA360	Saturn	KH.01K07.002
	WD	7200rpm 320GB WD3200AAJS-22L7A0	XL320S-3	KH.32008.016
		7200rpm 500GB WD5000AAKS-22V1A0 SATA II 16MB LF F/W:05.01D05		KH.50008.014
		7200rpm 640GB WD6400AAKS-22A7B2	XL320M	KH.64008.003
		7200rpm 1000GB WD1001FALS-22J7B0	XL333	KH.01K08.004
		5400rpm 1000GB WD10EADS-22M2B0	GP500	KH.01K08.005
5400rpm 1500GB WD15EADS-22P8B0	GP500	KH.15K08.001		

Component	Vendor	Description	Model	Part Number
	Seagate	7200rpm 320GB ST3320418AS(Pharaoh) SATA II 16MB LF F/W:CC44	Pharaoh	KH.32001.015
		7200rpm 640GB ST3640623AS(Brinks) SATA II 16MB LF F/W:CC4H	Brinks	KH.64001.002
		7200rpm 1000GB ST31000528AS(Pharaoh) SATA II 32MB LF F/W:CC44	Pharaoh	KH.01K01.007
		7200rpm 1500GB ST31500341AS(Brinks) SATA II 32MB LF F/W:CC4H	Brinks	KH.15K01.002
Optical drive	HLDS	ODD HLDS Super-Multi DRIVE 12.7mm Tray DL 8X	GT31N	KU.0080D.054
		ODD HLDS BD COMBO 12.7mm Tray DL 4X	CT21N	KO.0040D.004
	PLDS	ODD PLDS Super-Multi DRIVE 12.7mm Tray DL 8X	DS-8A5SH	KU.0080F.014
	Panasonic	ODD PANASONIC BD COMBO 12.7mm Tray DL 4X	UJ141AL	KO.00407.004
		ODD PANASONIC BD RW 12.7mm Tray DL 4X	UJ240A	KU.00407.015
TV tuner card	AverMedia	Avermedia H753-A TV Tuner Card PCIe Hybrid ATSC, S/W Encoder	H753-A	TU.10500.064
		Avermedia H753-D TV Tuner Card PCIe Hybrid DVB-T, S/W Encoder	H753-D	TU.10500.065
Graphics card	PCP	NV GT320 1GB sDDR3 DVI+HDMI LP (SAMSUNG)		VG.PCPT3.211
		NV GT320 1GB DDR3 DVI+HDMI LP (HYNIX 1.2ns)		VG.PCPT3.213
		HD5570 1GB DDR 3 (128BITS) SAMSUNG DVI HDMI W/LP BKT ROHS		VG.APC55.711
		HD5570 1GB 128bits sDDR3 DVI+HDMI LP (New Hynix - 1.2)		VG.APC55.732
		NV 315 512MB 64bits sDDR3 DVI+HDMI LP (New Hynix - 1.2)		VG.PCPT3.164
		HD5450 512MB SDDR 3 (64BITS) SAMSUNG DVI HDMI W/LP BKT ROHS		VG.APC54.511
		HD5450 512MB SDDR 3 (64BITS) SAMSUNG DVI HDMI W/LP BKT ROHS 4 LAYER		VG.APC54.513
		HD5450 512MB 64bits sDDR3 DVI+HDMI LP (New Hynix - 1.2)		VG.APC54.532
		HD5450 512MB 64bits sDDR3 DVI+HDMI LP 4 LAYER		VG.APC54.534

Component	Vendor	Description	Model	Part Number
	ECS	HD5450 512MB (64BIT) DDR3 DVI HDMI VGA LP BRACKET ROHS		VG.ECS54.511
		NV G315 512MB (64BIT) DDR3 DVI HDMI LP BRACKET ROHS		VG.ECS31.5L1
WLAN module	Lite-On	Lite-On WN6607LH WLAN WN6607LH, Realtek RTL8191SU, 802.11bgn 1Tx2R WLAN (mini-card)(USB interface) Half Size	WN6607LH	NI.10200.041
WLAN antenna	ACON_Main	ANTENNA MAN WLAN ACON Main AMM8P-700017	AMM8P-700017	25.91344.001
	ACON_Aux	ANTENNA AUX WLAN ACON_Aux AMM8P-700018	AMM8P-700018	25.91345.001
LCD panel with touchscreen function	eTurbo	eTurbo 21.5" resistive multi-touch panel Panel touch film	SR-215M181728D1	PC.14600.002
		eTurbo 23" resistive multi-touch panel Panel touch film	SR-230M182235D1	PC.14600.001
Touchscreen control board	Ideacom	Ideacom Resistive multi-touch control board IDC1650-090U0 (for 21.5")	IDC1650-090U0-01-00	PA.14800.001
		Ideacom Resistive multi-touch control board IDC1650-114U0 (for 23")	IDC1672-114U0-00-00	PA.14800.002
LCD panel	AUO	CCFL LCD AUO 21.5"W FHD None Glare M215HW01 V0 0G LF 300nit 5ms 1000:1	M215HW01 V0 Rev.0G	LK.21505.011
		CCFL LCD AUO 21.5"W FHD None Glare M215HW01 V0 0H LF 300nit 5ms 1000:1	M215HW01 V0 Rev.0H	LK.21505.012
	LGD	CCFL LCD LPL 21.5"W FHD None Glare LM215WF1 TLF1 LF 300nit 5ms	LM215WF1	LK.21508.006
	SEC	CCFL LCD SAMSUNG 23"W FHD None Glare LTM230HT01 A09 LF 300nit 5ms 1000:1 HF	LTM230HT01	LK.23006.014
		CCFL LCD SAMSUNG 23"W FHD None Glare LTM230HT01 A10 LF 300nit 5ms 1000:1 HF	LTM230HT01	LK.23006.015
	LGD	CCFL LCD LPL 23"W FHD None Glare LM230WF1 TLA5 LF 300nit 5ms G8	LM230WF1	LK.23008.009

Component	Vendor	Description	Model	Part Number
Power supply unit	Delta	DPS-220UB A	PY.22009.006	PY.22009.006
	CP	CPB09-D220R	PY.2200F.004	PY.2200F.004
	Delta	DPS-220UB-1 A	PY.22009.007	PY.22009.007
	CP	CPB09-D220A	PY.2200F.005	PY.2200F.005
	LiteOn	PS-5221-9AE-RoHS (FR 220W, ES)	PY.2200B.008	PY.2200B.008
	Delta	DPS-220UB-2 B (FR 220W, ES)	PY.22009.008	PY.22009.008
	CP	CPB09-D220E (FR 220W, ES)	PY.2200F.006	PY.2200F.006
Bluetooth module	Chicony	BT MODULE BT V2.1+EDR CSR BLUECORE4-PC-R	BC10B-04C1	56.25034.021
	Lite-on	BT MODULE BT V2.1+EDR CSR BC04-ROM CSP A	WB111C-C1-AA	56.25034.011
Webcam module with microphone	Chicony	CAMERA 2M CNFA21321004590L CHICONY	CNFA213	56.18007.521
	Simplo	CAMERA 2M 1007 C04PL037F PARKORCHID	C04PL037F	56.18009.521
Inverter board	Darfon	INVERTER 4L VZ.13156.101 DARFON	V156-B01 HF	19.21066.231
	Sumida	INVERTER 4L IV30260SPEC139 SUMIDA	IV30260/T-LF	19.21060.231
Speakers	Neosonica	5W_SPEAKER(L+R) 9C-032RA08K1P-01 DTX_AIO	C032RA08K1P-01	23.40817.001
USB keyboard	Chicony	Keyboard CHICONY KU-0420 USB 105KS Black US International		KB.USB03.247
		Keyboard CHICONY KU-0420 USB 105KS Black Spanish		KB.USB03.248
		Keyboard CHICONY KU-0420 USB 105KS Black Portuguese		KB.USB03.249
		Keyboard CHICONY KU-0420 USB 105KS Black Italian		KB.USB03.250
		Keyboard CHICONY KU-0420 USB 105KS Black Swedish		KB.USB03.251
		Keyboard CHICONY KU-0420 USB 105KS Black Dutch		KB.USB03.252
		Keyboard CHICONY KU-0420 USB 105KS Black Swiss/G		KB.USB03.253
		Keyboard CHICONY KU-0420 USB 105KS Black Belgium		KB.USB03.254
		Keyboard CHICONY KU-0420 USB 105KS Black Icelandic		KB.USB03.255
		Keyboard CHICONY KU-0420 USB 105KS Black Norwegian		KB.USB03.256
		Keyboard CHICONY KU-0420 USB 105KS Black Hebrew		KB.USB03.257
		Keyboard CHICONY KU-0420 USB 105KS Black Polish		KB.USB03.258
Keyboard CHICONY KU-0420 USB 105KS Black Slovenian		KB.USB03.259		

Component	Vendor	Description	Model	Part Number
		Keyboard CHICONY KU-0420 USB 105KS Black Slovak		KB.USB03.260
		Keyboard CHICONY KU-0420 USB 105KS Black Russian		KB.USB03.261
		Keyboard CHICONY KU-0420 USB 105KS Black Hungarian		KB.USB03.262
		Keyboard CHICONY KU-0420 USB 105KS Black Greek		KB.USB03.263
		Keyboard CHICONY KU-0420 USB 105KS Black Danish		KB.USB03.264
		Keyboard CHICONY KU-0420 USB 105KS Black Czech		KB.USB03.265
		Keyboard CHICONY KU-0420 USB 105KS Black Romanian		KB.USB03.266
		Keyboard CHICONY KU-0420 USB 105KS Black Turkish		KB.USB03.267
		Keyboard CHICONY KU-0420 USB 105KS Black UK		KB.USB03.268
		Keyboard CHICONY KU-0420 USB 105KS Black French		KB.USB03.269
		Keyboard CHICONY KU-0420 USB 105KS Black German		KB.USB03.270
		Keyboard CHICONY KU-0420 USB 105KS Black Nordic		KB.USB03.271
		Keyboard CHICONY KU-0420 USB Standard 105KS Black Arabic/English		KB.USB03.272
RF keyboard	Chicony	Keyboard CHICONY WUG0570 RF2.4 105KS Black US International with PB logo		KB.RF403.186
		Keyboard CHICONY WUG0570 RF2.4 105KS Black Spanish with PB logo		KB.RF403.187
		Keyboard CHICONY WUG0570 RF2.4 105KS Black Portuguese with PB logo		KB.RF403.188
		Keyboard CHICONY WUG0570 RF2.4 105KS Black Italian with PB logo		KB.RF403.189
		Keyboard CHICONY WUG0570 RF2.4 105KS Black Swedish with PB logo		KB.RF403.190
		Keyboard CHICONY WUG0570 RF2.4 105KS Black Dutch with PB logo		KB.RF403.191
		Keyboard CHICONY WUG0570 RF2.4 105KS Black Swiss/G with PB logo		KB.RF403.192
		Keyboard CHICONY WUG0570 RF2.4 105KS Black Belgium with PB logo		KB.RF403.193

Component	Vendor	Description	Model	Part Number
		Keyboard CHICONY WUG0570 RF2.4 105KS Black Icelandic with PB logo		KB.RF403.194
		Keyboard CHICONY WUG0570 RF2.4 105KS Black Norwegian with PB logo		KB.RF403.195
		Keyboard CHICONY WUG0570 RF2.4 105KS Black Hebrew with PB logo		KB.RF403.196
		Keyboard CHICONY WUG0570 RF2.4 105KS Black Polish with PB logo		KB.RF403.197
		Keyboard CHICONY WUG0570 RF2.4 105KS Black Slovenian with PB logo		KB.RF403.198
		Keyboard CHICONY WUG0570 RF2.4 105KS Black Slovak with PB logo		KB.RF403.199
		Keyboard CHICONY WUG0570 RF2.4 105KS Black Russian with PB logo		KB.RF403.200
		Keyboard CHICONY WUG0570 RF2.4 105KS Black Hungarian with PB logo		KB.RF403.201
		Keyboard CHICONY WUG0570 RF2.4 105KS Black Greek with PB logo		KB.RF403.202
		Keyboard CHICONY WUG0570 RF2.4 105KS Black Danish with PB logo		KB.RF403.203
		Keyboard CHICONY WUG0570 RF2.4 105KS Black Czech with PB logo		KB.RF403.204
		Keyboard CHICONY WUG0570 RF2.4 105KS Black Romanian with PB logo		KB.RF403.205
		Keyboard CHICONY WUG0570 RF2.4 105KS Black Turkish with PB logo		KB.RF403.206
		Keyboard CHICONY WUG0570 RF2.4 105KS Black UK with PB logo		KB.RF403.207
		Keyboard CHICONY WUG0570 RF2.4 105KS Black French with PB logo		KB.RF403.208
		Keyboard CHICONY WUG0570 RF2.4 105KS Black German with PB logo		KB.RF403.209
		Keyboard CHICONY WUG0570 RF2.4 105KS Black Nordic with PB logo		KB.RF403.210

Component	Vendor	Description	Model	Part Number
Keyboard dongle receiver	Chicony	Chicony Dangle Receiver USB external receiver		RV.11000.022
USB mouse	Chicony	Chicony optical mouse USB MSU0960		MS.11200.061
MCE remote controller/ receiver	Philips	Philips Remote Controller RC2604307/01BG for EMEA ;pair with RV.11000.007	EMEA Win7/Philips	RT.11300.021
		Philips Remote Controller RC2604301/01B MSFT code EMEA;pair with OVU430005	EMEA Win7 WMC	RT.11300.023
		Philips Remote Controller RC2604302/01B MSFT code US;pair with OVU430005	US Win7 WMC	RT.11300.022
		Philips Remote Controller RC2604701/01B MSFT code Japan; pair with OVU430005	US Win7 WMC	RT.11300.024
	SMK	SMK Remote Controller US RRS9003-3406E SMK Quatro Pulse;with Battery Pack	US Win7 WMC_SMK	RT.11300.025

Online Support Information

This section describes online technical support services available to help you repair your Acer products.

If you are a distributor, dealer, ASP or TPM, please refer your technical queries to your local Acer branch office. Acer branch offices and regional business units can access our website. However some information sources will require a user ID and password. These can be obtained directly from Acer CSD Taiwan.

Acer's website offers you convenient and valuable support resources whenever you need them.

In the Technical Information section you can download information on all Acer notebook, desktop and server models including:

- Service guides for all models
- User's manuals
- Training materials
- BIOS updates
- Software utilities
- Spare parts lists
- TABs (Technical Announcement Bulletin)

For these purposes, we have included a PDF file to facilitate the problem-free downloading of our technical material.

Also available on this website are:

- Detailed information on Acer's International Traveler's Warranty (ITW)
- Returned material authorization procedures
- An overview of all the support services we offer, accompanied by a list of telephone, fax and email contacts for all your technical queries.

We are always looking for ways to optimize and improve our services, so if you have any suggestions or comments, please do not hesitate to communicate these to us.

-
- A**
- AC power jack 4
 - ACPI, see Advanced Configuration Power Interface 2
 - Advanced BIOS Features menu 16
 - Advanced Chipset Features menu 17
 - Advanced Configuration Power Interface
 - specifications 2
 - wake-up options 19
 - antivirus software 2
 - audio
 - headphone jack 5
 - line-in jack 4
 - line-out jack 4
 - microphone jack, left 4
 - microphone jack, right 5
 - specifications 9
 - troubleshooting 74
 - audio features 1
- B**
- beep codes 76
 - BIOS
 - checkpoints 62
 - clear CMOS 78
 - crisis recovery disk 77
 - recovery 77
 - specifications 7
 - system passwords 22
 - version 14
 - BIOS Security Features menu 22
 - block diagram 79
 - Bluetooth
 - cable, part number 88
 - module, part number 85
 - module, remove 52
 - specifications 9
 - boot block
 - checkpoints 62
 - execute 77
 - boot sequence 16
 - brightness control keys 3
- C**
- cable cover
 - location 4
 - capacitive keys 3
 - capacitive LED board
 - remove 59
 - card reader
 - location 4
 - supported cards 1
 - checkpoints
 - boot block 62
 - DIM 66
 - overview 62
 - POST 64
 - CMOS clear 78
 - CMOS Setup Utility
 - access 12
 - Advanced BIOS Features menu 16
 - Advanced Chipset Features menu 17
 - BIOS Security Features menu 22
 - Exit Without Saving 24
 - Frequency/Voltage Control menu 21
 - Integrated Peripherals menu 18
 - Load Default Settings 24
 - navigation keys 13
 - overview 11
 - PC Health Status menu 20
 - Power Management Setup menu 19
 - Product Information menu 14
 - Save & Exit Setup 24
 - Standard CMOS Features menu 15
 - computer stand
 - location 6
 - remove 26
 - connectivity
 - Bluetooth 9
 - Ethernet 9
 - WLAN 9
 - connectivity features 2
- D**
- DIM checkpoints 66
 - disassembly procedures
 - Bluetooth module 52
 - capacitive LED board 59
 - computer stand 26
 - graphics card 37
 - guidelines 83
 - hard disk drive 40
 - heat sink fan 43
 - I/O cable cover 27
 - I/O cable plate 28
 - inverter board 42
 - inverter board bracket 37
 - LCD assembly 54
 - LCD board cover 58
 - LCD cable 58
 - light bars 60
 - main chassis 56
 - mainboard 47
 - memory 46
 - optical disc drive 29
 - power button assembly 53
 - power supply unit 49
 - preparatory steps 25

- processor 44
- rear cover 28
- RTC battery 46
- rubber feet 27
- scaler board 31
- tools 25
- touchscreen control board 51
- TV tuner card 36
- USB/audio board 33
- wall mount plate 35
- webcam module 59

display

- display by model 1
- remove LCD assembly 54
- remove LCD board cover 58
- remove LCD cable 58

E

- eSATA port 4
- Ethernet
 - port location 4
 - specifications 9
- Exit Without Saving menu 24
- expansion slots
 - location 80
 - specifications 1
- exploded view 84

F

- Field Replaceable Unit, see FRU list 83
- Frequency/Voltage Control menu 21
- FRU list
 - components list 85
 - exploded view 84
 - part number updates 83

G

- graphics card
 - part number 85
 - remove 37

H

- hard disk drive
 - configuration 15
 - part number 87
 - remove 40
 - SATA connectors 81
 - specifications 8
 - troubleshooting 73
- hardware
 - configuration utility 11
 - exploded view 84
 - FRU list 83
 - information display 14
 - model configurations 95
 - specifications 7
 - status monitoring 20
 - troubleshooting 61
- HDD, see hard disk drive 1
- HDMI port 4

- headphone jack 5
- heat sink fan
 - cable connector 81
 - part number 86
 - remove 43
- HSF, see heat sink fan 43

I

- I/O cable cover
 - remove 27
- I/O cable plate
 - remove 28
- I/O ports
 - listing 1
- Integrated Peripherals menu 18
- inverter board
 - bracket, remove 37
 - part number 85
 - remove 42
 - supported models 10
- inverter cable
 - part number 88

K

- keyboard
 - part number 89

L

- LAN port
 - location 4
 - specifications 9
- LCD board cover
 - remove 58
- LCD cable
 - remove 58
- LCD panel
 - part numbers 88
 - specifications 9, 10
- light bars
 - cable, part number 88
 - remove 60
- Load Default Settings menu 24

M

- main chassis
 - remove 56
- mainboard
 - component identification 80
 - part number 85
 - remove 47
 - specifications 2
 - troubleshooting 72
- media storage 1
- memory
 - check size 14
 - DIMM slots 81
 - part number 86
 - remove 46

- specifications 1, 8
- troubleshooting 72
- microphone jack
 - left 4
 - right 5
- model configurations 95
- modem board
 - troubleshooting 74
- monitor port 4
- mouse
 - part number 91

O

- ODD bezel, remove 30
- ODD, see optical disc drive 1
- online support information 110
- operating system 2
- optical disc drive
 - bracket, remove 30
 - configuration 15
 - location 4
 - part number 87
 - remove 29
 - specifications 8
 - troubleshooting 73
- OS support 2

P

- part numbers
 - AC power cord 89
 - accessories 91
 - Bluetooth cable 88
 - Bluetooth module 85
 - graphics card 85
 - hard disk drive 87
 - HDD SATA cable 88
 - heat sink fan 86
 - inverter board 85
 - inverter cable 88
 - keyboard 89
 - LCD panel 88
 - light bar cable 88
 - mainboard 85
 - memory module 86
 - microphone cable 88
 - mouse 91
 - ODD SATA cable 88
 - optical disc drive 87
 - power button assembly 85
 - power button/LED cable 88
 - power supply unit 89
 - processor 86
 - screws 91
 - speaker cable 88
 - touchscreen control board 85
 - TV tuner card 86
 - USB Bluetooth cable 88
 - USB/audio board cable 88
 - webcam cable 88

- webcam module 85
- wireless LAN card 86
- WLAN cable 88

- PC Health Status menu 20
- POST, see Power-On Self-Test 64

- power
 - AC power jack 4
 - ACPI compliance 2
 - button assembly, part number 85
 - button assembly, remove 53
 - button/indicator 3
 - specifications 2
 - wake-up options 19

- power management

- configure 19
 - specifications 2

- power supply unit

- 24-pin ATX connector 81
 - 4-pin ATX connector 81
 - part number 89
 - remove 49
 - supported models 10
 - troubleshooting 75

- Power-On Self-Test

- beep codes 76
 - checkpoints 64
 - error messages 66

- processor

- check type/speed 14
 - part number 86
 - remove 44
 - socket 81
 - specifications 7
 - troubleshooting 72

- Product Information menu 14

- PS/2 keyboard port 4

- PS/2 mouse port 4

- PSU, see power supply unit 49

R

- rear cover

- remove 28

- Return Merchandise Authorization 83

- RMA, see Return Merchandise Authorization 83

- RTC battery

- BIOS error 11
 - location 81
 - remove 46

- RTC clock

- RTC battery 81
 - troubleshooting 74

- rubber feet

- remove 27

S

- Save & Exit Setup menu 24
- scaler board
 - remove 31
- security features 2
- separators
 - location 3
- serial-to-DVI port
 - cable, remove 47
 - location 4
- soakers
 - cable, part number 88
- software specifications
 - operating system 2
- speakers
 - remove 54
- specifications
 - antivirus 2
 - audio 9
 - BIOS 7
 - Bluetooth 9
 - display 9, 10
 - Ethernet controller 9
 - hard disk drive 8
 - memory 8
 - optical disc drive 8
 - power supply unit 10
 - processor 7
 - system chipsets 7
 - webcam 9
 - WLAN controller 9
- Standard CMOS Features menu 15
- supervisor password 22
- system architecture 79
- system chipset 1
- system chipsets 7
- system date 15
- system dimensions 2
- system passwords
 - change 23
 - remove 23
 - set 23
- system time 15
- system views
 - front view 3
 - left view 4
 - rear view 6
 - right view 5

T

- temperature
 - monitoring 20
- touchscreen
 - by model 10
 - control board, part number 85
 - control board, remove 51
- troubleshooting
 - BIOS checkpoints 62
 - BIOS recovery 77
 - clearing CMOS 78
 - component failure 72
 - hardware diagnostic procedure 61
 - online support information 110
 - POST error indicators 66
- TV tuner card
 - part number 86
 - remove 36

U

- undetermined problems 76
- USB ports
 - bootable device 18
 - left 4
 - legacy device 18
 - right 5
- USB/audio board
 - cable, part number 88
 - remove 33
- user password 22

V

- VGA port 4
- video
 - troubleshooting 74
- volume control keys 3

W

- wall mount option 6
- wall mount plate
 - remove 35
- webcam
 - cable, part number 88
 - location 3
 - module, part number 85
 - module, remove 59
 - specifications 9
- wireless LAN
 - cable, part number 88
 - card, part number 86
- WLAN
 - specifications 9