

User's Manual



Contents

Note	51
-------------	-----------

Important Safety Information	55
-------------------------------------	-----------

Wireless LAN	57
Additional safety notes for units with wireless LAN	58
CE-labelling for units with wireless LAN	59
Restrictions	60
France	60
Italy	60
Netherlands	60
Radio frequencies for units with wireless LAN	61
Legal requirements - exception clauses	62

Shipping Contents	63
--------------------------	-----------

Preparation	65
--------------------	-----------

Inserting the Battery	66
Removing the Battery	66
Power Supply	67
Switching the Computer on	68
Power Management	69

System Overview	71
------------------------	-----------

Left Side	71
Right Side	71
Front View	71
Rear View	72
Underside	72
Explanation of LED Displays	73
Hot Keys	74
The Quick Buttons (Quick Launch keys)	75
The Keyboard	76
The TouchPad	77
The TouchPad - Operation	77
The CD-ROM/DVD Drive	78
The PC Card Slot	79
The Memory Card Slot	79
The Data/Fax Modem	80
The LAN Port	80

UK

Installation Instructions	81
Restoring the Drivers.....	81
The Utility CD	81
Setting the Resolution	81
Specifications	83
Fault Diagnosis and Troubleshooting	87
Index	89

Note

The company reserves the right to make unadvertised modifications to this document. Information contained in this document is intended solely for reference purposes and in no way constitutes a basis for asserting obligations on the part of the manufacturer or vendor. Neither the manufacturer nor the vendor accept liability for any errors or inaccuracies that this document may contain. Nor is liability accepted for damages or losses that arise from the incorrect application of this guide. No part of this document and the accompanying software may be copied, translated, or distributed without the prior permission of the dealer, manufacturer, or authors. Archive copies for private use are excepted from this rule. The use of this product's trademarks is subject to the conditions listed in the advanced service handbook on the device drivers and utilities CD-ROM. Brand or product names mentioned in this document may be names protected by copyright law or registered trademarks of other companies. These are mentioned only for identification purposes and have no recommendatory character in regard to the product or manufacturer.

© MAXDATA 2005

Legal Information

You can find additional legal information and conditions in the advanced service handbook on the device drivers and utilities CD-ROM (Utility CD).

Acrobat and the Acrobat Logo are trademarks of Adobe Systems Incorporated or its subsidiaries. In certain jurisdictions these trademarks may be registered.

Intel® and Pentium® are registered trademarks of Intel Corporation. MS-DOS®, Microsoft® Windows®, Microsoft® Windows® 95, Microsoft® Windows® 98, Microsoft® Windows® Me, Microsoft® Windows® 2000, Microsoft® Windows® XP, and Microsoft® Windows® NT are registered trademarks of Microsoft.

Application and References

This user guide offers an introduction and is intended to provide instructions for your first steps with your new computer.

For more in-depth specialist information, please consult the advanced service handbook.

All references refer to the accompanying device drivers and utilities CD-ROM, which contains the advanced service handbook (in Adobe Acrobat format), drivers, and special utilities for your notebook. If you wish to use an operating system that is not mentioned in these documents, consult the ReadMe files on the CD-ROM for the relevant information. Please also consult your dealer to make sure that it is possible to run your chosen operating system on your notebook. The operating system is not contained on the device drivers and utilities CD-ROM.

Note: Some or all system configurations may have been made already. If this is not the case or if parts of the system need to be reconfigured, please consult the advanced service handbook on the device drivers and utilities CD-ROM for instructions on how to do this.

Declaration:

This device meets the EN 55022 product standard for interference emissions, the EN 50082-1 basic standard for interference, and the EN 60950 low voltage directive standard. If any modification that has not been agreed upon with the manufacturer is made to the device, adherence to these standards can no longer be guaranteed. To ensure electromagnetic compatibility (EMC), please observe the information given in the handbook.

Sound Power Level

The workplace-based sound power level is less than 55 dB A.

Federal Communications Commission (FCC) Note

This device has been tested and found to comply with the limits for a Class B digital device, pursuant to Part 15 of the FCC Rules.

Warranty

The warranty period for the device is 24 months. In the case of damage occurring outside the scope of the warranty, it is the intention to offer repair of the devices through original replacement parts or exchange of modules or devices with cost for at least 3 years (from end of production).

Operator Note:

This device has been carefully RF suppressed and tested to avoid radio interference. However, please pay attention to the following concerning external data cables:

If it becomes necessary to replace a data cable specified by the manufacturer, the operator must ensure that replacement cables also match the original cable in terms of screening quality for correct radio interference suppression.

Use only screened cables and external devices that are identical with this product in terms of safety level and EMC behavior.

In the event of non-observance, compliance with the standards mentioned above is no longer guaranteed!

Optical Disk Drive (ODD):

Built-in ODDs are Class 1 laser products. Do not open the device and do not look into the beam, even using optical instruments.

Unless the drive is expressly designated for the simultaneous use of more than one CD, never insert more than one CD into the drive.



Returning the Device/Battery

We accept the return of all our products after they have been used if the condition corresponds to standard proper usage. Returned devices are either slated for further use or dismantled and recycled in an environmentally sound manner. The return is handled through your dealer.

Rechargeable and disposable batteries containing heavy metals should not be thrown in with household waste. They are accepted free of charge by manufacturers, dealers or their representatives for recycling or disposal.

The outside packaging and all inner parts of the box can be disposed of as waste paper.



Important Safety Information

Although the notebook is highly robust, it is not indestructible. To prevent damage from occurring, please pay attention to the following:

- Avoid exposing the notebook to strong shocks or vibrations.
- Keep it away from intense heat (radiators, direct sunlight).
- Protect the notebook from electromagnetic interference. This will also prevent data loss.
- Don't expose it to moisture. This is an electrical device!
- Be sure to use the correct power supply.
- Always use an approved power adapter.



The power adapter requires a fluctuation-free and uninterrupted power supply. If you have any questions, consult your local electricity supply company.

The power adapter must be fitted with a grounded (earthed) plug.

Never pull on the cable to unplug the power supply – always pull the plug itself.

Disconnect the external power supply (power adapter or car adapter) before cleaning the computer.

- Notes on Using Batteries



Only use batteries designed exclusively for use with this computer.

Recharge batteries via the notebook.

Do not attempt to repair faulty batteries yourself. Entrust repairs to your dealer or qualified service personnel.

Keep damaged batteries away from children and dispose of them properly as soon as possible. Exercise caution in handling damaged batteries. Batteries may explode if exposed to fire or improperly handled or disposed of.

The notebook is provided with a battery. The battery is recyclable. It is prohibited by law to dispose of the battery in ordinary household waste. If you have questions concerning proper disposal, consult your garbage collection service.

-
- Note on the System Clock Battery



Caution: There is a risk of explosion if batteries are replaced incorrectly. Replace the battery only with a battery recommended by the manufacturer or with a battery of the same type. Dispose of the battery according to the manufacturer's instructions.

- Servicing

Do not service your computer yourself! You could invalidate your warranty rights and expose yourself and the device to the risk of electrical shock. If servicing is required, consult qualified service personnel. Disconnect the computer from the power supply.

If the following problems occur, consult qualified service personnel:



- Power adapter or power cable is damaged or frayed.
- Liquid has entered the computer.
- Despite operating it correctly, the computer is not functioning properly.
- The computer has been dropped or damaged.

- Cleaning

Never apply cleaning agents directly to the computer. Use only a soft, lint-free cloth. Never use volatile (petroleum distillates) or scouring cleaning agents.

Wireless LAN

(wireless network - abbreviation = WLAN)

Your notebook may contain a wireless LAN module (optional). This module allows you to set up a wireless-based network, and to connect to an existing wireless network. It works according to the IEEE802.11b+g standard.

WLAN technology allows users to set up wireless connections inside a local area (e.g. in a company or campus building, or in a public building such as an airport). WLANs can be used in temporary offices, in locations where it is not possible to set up extensive cable installations, or to extend an existing LAN so that users in different parts of a building can work at different times.

There are two different ways to operate a WLAN.

In fixed WLANs, wireless stations (devices with radio network cards or external modems) set up connections with wireless access points, which act as bridges between the stations and the existing network backbone. In Peer-to-Peer (ad hoc) WLANs several users can set up a temporary network within a limited area such as a conference room, without using access points, and providing there is no need to use network resources.

In 1997 the IEEE confirmed the standard 802.11 for WLANs; this set a data transfer rate of from 1 to 2 Mbit/s (Megabits per second). With 802.11b+g, the new governing standard, the maximum data transfer rate is 54 Mbit/s over a frequency band of 2.4 GHz (Gigahertz).

Additional safety notes for units with wireless LAN

If a wireless LAN module is integrated in your notebook, it is essential that you observe the following safety information when using your notebook:



- Switch off the Notebook when you are in an aircraft or while driving a car.
- If you are in a hospital, an operating room or close to an electronic medical system, switch off the wireless components in the Notebook! The radio waves which are transmitted could disrupt the working of the medical equipment.
- Keep the Notebook at least 20 cm away from a heart pacemaker, otherwise there is a risk that the radio waves could disrupt the normal working of the pacemaker.
- The radio waves which are transmitted could give rise to interference noise in hearing aids.
- When its radio components are switched on, do not place the Notebook close to inflammable gases or in an environment which could be at risk of explosion (e.g. paint shop), since the radio waves which are transmitted could set off a fire or an explosion.
- The range of the wireless connection depends on the environmental and other ambient conditions.
- When transferring data over a wireless connection, unauthorized Third Parties can also receive the data.

MAXDATA Computer AG is not responsible for disruptions to radio or television reception which are caused by unauthorized alterations to this unit. MAXDATA also accepts no responsibility for the replacement or the exchange of connecting cables and units which were not specified by MAXDATA Computer AG. The user alone is responsible for the elimination of disruptions caused by this type of unauthorized alteration; he is also responsible for the replacement or the exchange of the units.

CE-labelling for units with wireless LAN



As delivered, this device complies with the requirements of the Guideline 1999/5/EG of the European Parliament and of the Council dated the 9. March 1999 concerning radio equipment and telecommunications facilities, and the mutual recognition of conformity.

This Notebook may be used in Belgium, Denmark, Germany, Finland, France, Greece, Great Britain, Ireland, Italy, Luxembourg, the Netherlands, Austria, Portugal, Sweden, Switzerland, Spain, Iceland, Liechtenstein and Norway.

Current information on any possible restrictions in its operation can be obtained from the appropriate authorities in each country. If your country is not included in the above list, then please contact the appropriate supervising authority, in order to check whether the use of this product is permitted in your country.

Belgium - www.bipt.be

Denmark - www.tst.dk

Germany - www.regtp.de

Finland - www.ficora.fi

France - www.art-telecom.fr

Greece - www.eett.gr

England - www.oftel.gov.uk

Ireland - www.comreg.ie

Italy - www.agcom.it

Luxembourg - www.etat.lu/ILT

Netherlands - www.opta.nl

Austria - www.rtr.at

Portugal - www.urt.gov.pt

Sweden - www.pts.se

Switzerland - www.bakom.ch

Spain - www.cmt.es

Iceland - www.pta.is

Liechtenstein - www.ak.li

Norway - www.npt.no

UK

Restrictions

France

Restricted frequency range: In France, you may only use channels 10 to 11 (2457 MHz or 2462 MHz). It is forbidden to use the unit outside of enclosed areas.

Info: www.art-telecom.fr

Italy

An official authorization is also required to use the unit in internal areas. For more detailed information about the necessary procedure to do this, please contact your provider.

It is forbidden to use the unit outside of enclosed areas.

Info: www.agcom.it

Netherlands

A licence is required to use the unit in the open. For more detailed information about the procedure to be followed for this, please contact your provider.

Info: www.opta.nl

Radio frequencies for units with wireless LAN

The following information was correct at January 2002. You can obtain current information from the appropriate authorities in your country (e.g. www.regtp.de).

FREQUENCIES

Radio network cards and adapters are designed in accordance with IEEE-Standard 802.11b+g for use in the ISM frequency band (Industrial, Scientific, Medical) between 2.4 and 2.4835 GHz. Because of the DSSS-procedure (Direct Sequence Spread Spectrum), each of the 11 usable radio channels takes up a width of 22 MHz; this means that up to three, independent channels are available (e.g. 3, 8 and 11). The following table lists the authorised channels in your country:

Channel	MHz	Europe, R&TTE	France, R&TTE
1	2412	X	
2	2417	X	
3	2422	X	
4	2427	X	
5	2432	X	
6	2437	X	
7	2442	X	
8	2447	X	
9	2452	X	
10	2457	X	X
11	2462	X	X

UK

Legal requirements - exception clauses

EXCEPTION CLAUSES FOR UNITS WITH WIRELESS LAN

The installation and use of an unit with Wireless LAN may only take place when in accordance with the instructions contained in the user documents. The user documents are included in the material supplied with the product. All alterations or modifications made to this unit which are not expressly authorised by the manufacturer may lead to cancellation of the right of the user to operate the unit. The manufacturer is not liable for radio disruptions during the reception of radio and television signals which are due to non-authorised alterations to the unit or to the exchange or connection of cables and accessories, where these are not in accordance with the recommendations of the manufacturer. It is the responsibility of the user to remove any interference which may arise as a result of any non-authorised alterations, or the addition or replacement of components. Neither the manufacturer nor his authorised dealer and wholesaler are liable for damages or breaches of legal regulations which result from an infringement of these guidelines.

Shipping Contents

Before you begin installing your notebook, make sure that all components are present. If any item listed in the shipping contents is missing from your computer package, please contact your dealer immediately.

- Notebook
- Battery
- Utility CD
- Power adapter
- Power cable
- User guide
- DVD-ROM drive or DVD/CD-RW combo or DVD Dual +/-RW drive
- Modem cable

Please retain the original packaging in case you need to send the device for repairs or upgrades. Please store the packaging safely.



Preparation

Before first using the computer, make sure you are familiar with the individual components of your system.

Slide the release catch (1) to the right and open the display (2).

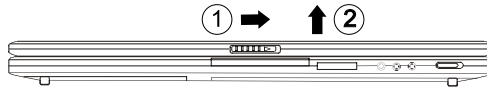

Fig. 1

- (1) Release catch
- (2) Open the display

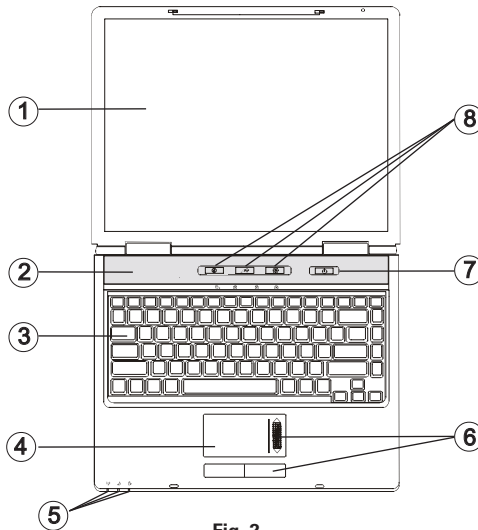

Fig. 2

- (1) LCD display
- (2) Loudspeakers
- (3) Keyboard
- (4) TouchPad
- (5) Status LEDs
- (6) Keys and scroll pad
- (7) Power button
- (8) Quick launch keys

UK

Inserting the Battery

The battery is included in the notebook's shipping contents. This battery is only partially charged.

Note that the charging time for the battery is three hours if the computer is switched off, or four and a half hours if the computer is switched on.



It is absolutely essential to fully charge the battery for initial operation! Do not unplug the power adapter until the battery is fully charged.

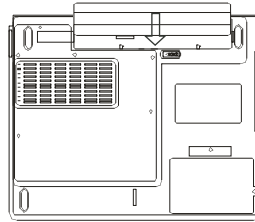

Fig. 3

1. Place the notebook bottom-side up on a flat and secured surface.
2. Carefully insert the battery pack into the battery compartment of the notebook.

Removing the Battery

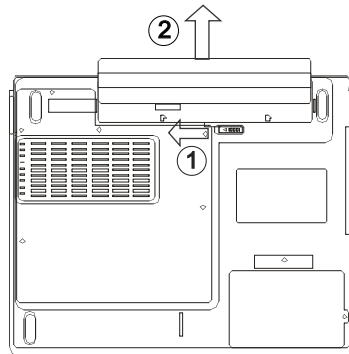

Fig. 4

1. Place the notebook bottom-side up on a flat and secured surface.
2. Push the latch and pull the battery's hard case away from the notebook.

You can now run the notebook with the power adapter alone!

Power Supply

The notebook is supplied with a power cable and a universal, self-adjusting power adapter. The power adapter can operate with any constant voltage between 100 and 240 volts.

To use the power adapter:

1. Connect the power adapter to the DC IN socket on the computer.
2. Connect the power cable to the power adapter.
3. Connect the power cable to a power outlet.



You can choose to run the notebook via battery or power supply. The first time you use the computer, you need to use the power adapter. Use only the supplied power adapter. Using the wrong power adapter can cause damage to the computer. The power adapter contains no service-able parts.

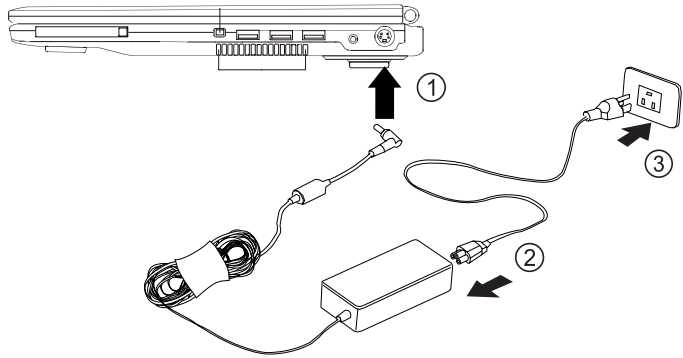

UK



**NEVER OPEN THE
POWER ADAPTER!**

**RISK OF FATAL
INJURY!**

Switching the Computer on

You've now completed the preparations. Now press the ON/OFF button to switch on the notebook.

Tip:

If you experience a program or system crash, press the following key combination:

Ctrl + Alt + Del

In most cases, only the task that has crashed will be ended or the computer will be re-started (warm restart).

If this does not work, hold down the on/off button for more than four seconds – this will switch off the computer. You can now restart the computer in the normal fashion (cold restart).



Please note that with Microsoft® Windows® operating systems you should always switch off the computer as follows:

Click the Start button.

Select Shut Down.

Click OK.

This avoids any problems with the hard disk and operating system.

Once the computer is switched on, the on/off button can perform several functions depending on the energy settings. In the standard setting, pressing the on/off button again will switch off the computer.

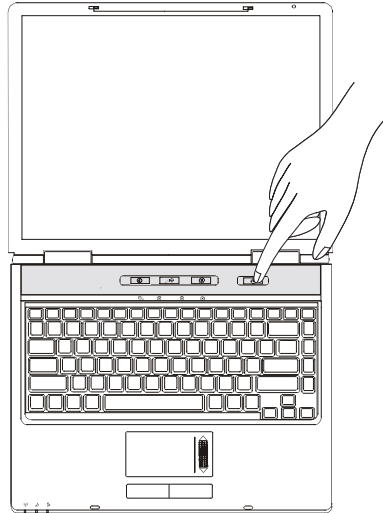

Fig. 5

The operating system is turned on the first time you switch on the computer. Please follow the installation instructions from the operating system at this point.

After installing the operating system and restarting, the computer is ready to use.

You can change some of the basic display settings such as the resolution, color depth and desktop background image.

You can find more detailed information on this point in the installation instructions.

Power Management

Your system is compatible with the ACPI power saving system.

The basic power management settings can be found under the following in Microsoft® Windows® operating systems: <Settings> <Power Options>. If you have questions, use the Microsoft® Windows® Help function.

Here you can set the behavior separately for various battery charge levels.

Standby: – low energy consumption –

The display is dimmed and the hard disk remains unchanged. The power LED flashes. By pressing the on/off button, the computer returns to the normal operating state. The user must log on again.

Hibernating: – without power adapter no energy consumption –

The current operating state is saved to the hard disk; the computer is switched off. All open documents or applications become available again when the computer is switched on.

Switching off the notebook and disconnecting it from the power supply (pulling the plug of the power adapter) can prevent any energy consumption.

- Note on PC cards:



Never remove a PC card while the system is in save-to-disk mode. This deactivates the PC slot, thus changing the system configuration. This can lead to problems the next time the computer is started.



System Overview

Left Side

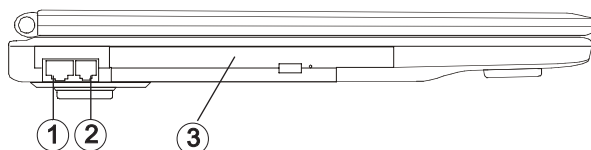

Fig. 6

- (1) LAN port
- (2) Modem port
- (3) Optical drive

Right Side

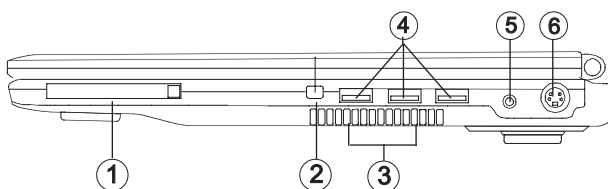

Fig. 7

- (1) PC card slot
- (2) IEEE 1394 port
- (3) Ventilation grill
- (4) USB ports
- (5) Socket for power adapter
- (6) S-Video TV output

Front View

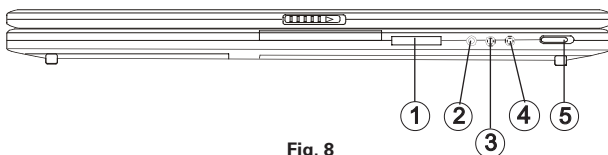

Fig. 8

- (1) Memory card slot
- (2) Microphone socket
- (3) Audio line-in socket
- (4) Loudspeakers / headphones / SPDIF out
- (5) Wireless on/off switch

Rear View



All air intake and ventilation openings must be kept free from obstructions at all times. If not, the device is liable to overheat.

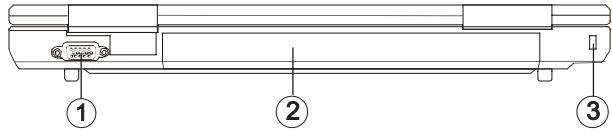

Fig. 9

- (1) Connector for external monitor
- (2) Battery Pack
- (3) Kensington lock - anti-theft device

Underside



All air intake and ventilation openings must be kept free from obstructions at all times. If not, the device is liable to overheat.

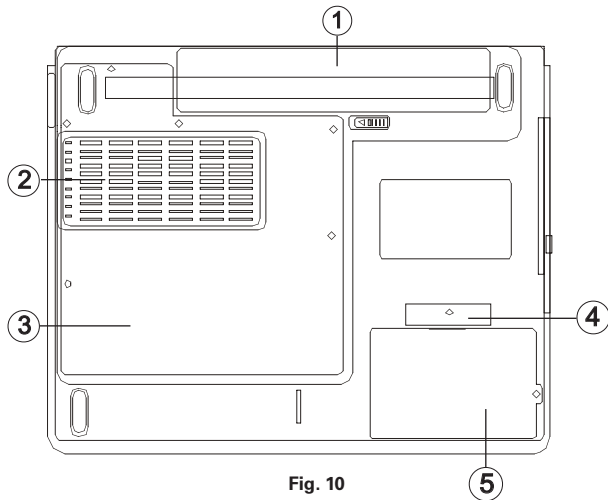

Fig. 10

- (1) Battery slot
- (2) Ventilation grill
- (3) System device cover
- (4) USB device cover
- (5) Hard disk drive cover

Explanation of LED Displays

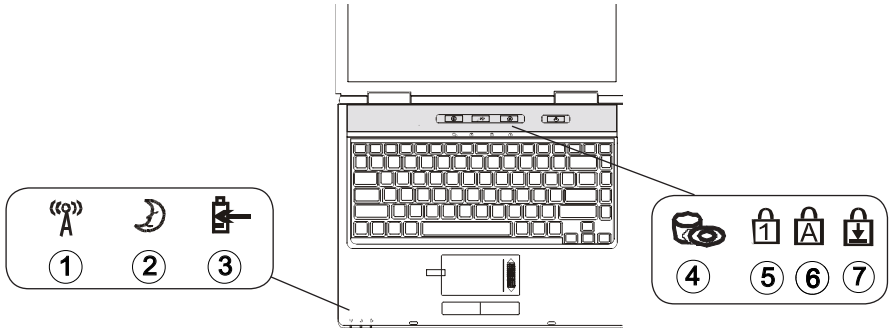

Fig. 11

- (1) Wireless LAN
- (2) Standby
- (3) Battery Charge / Power
- (4) Drive Access
- (5) Num Lock
- (6) Caps Lock
- (7) Scroll Lock

Table 1

Symbol	Meaning
	Lights when the wireless LAN is activated.
	Flashes in power saving mode.
	Flashes orange when the battery is charging and lights green when it's fully charged.
	Lights when the hard disk or optical drive is being accessed.
	Lights when Num Lock is on.
	Lights when Caps Lock is on.
	Lights when Scroll Lock is on.

Hot Keys

(Shortcut key combinations with special functions)

To activate the hot keys, press and hold down the Fn key and then press the desired additional key. For certain functions it may be necessary to install the Quick Button software. You can find additional information on this on the next page.

Table 2

Keys	Meaning
Fn + F1	Switches to power saving mode
Fn + F3	Turns the battery warning beep off or on
Fn + F4	Switches between LCD display/monitor/both
Fn + F5	Increases the volume
Fn + F6	Reduces the volume
Fn + F7	Increases LCD brightness
Fn + F8	Decreases LCD brightness
Fn + Num Lk	Enables the embedded keypad to work in numeric mode
Fn + Scr Lk	Press the Fn + Scr Lk key and then press the up arrow or the down arrow to move one line up or down

The Quick Buttons (Quick Launch keys)

There are three Quick buttons just above the keyboard. You can use these to launch frequently used applications.

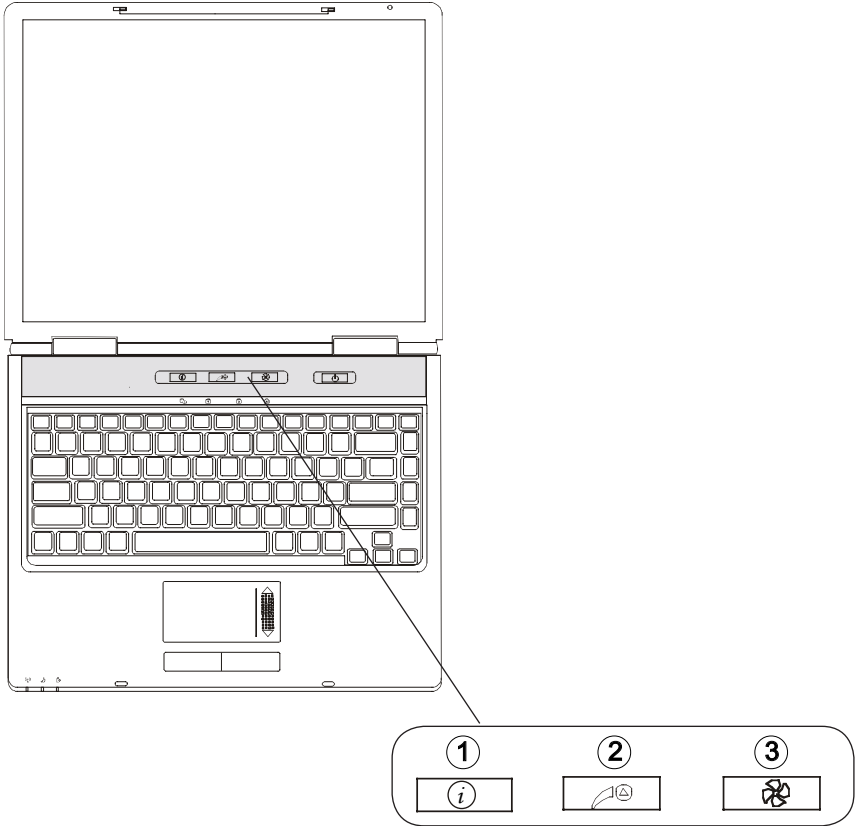

Fig. 12

- (1) Internet – Pressing the button launches Internet Explorer in Windows.
- (2) E-mail – Pressing the button launches the Outlook Express E-mail in Windows.
- (3) Silent mode – Pressing the key enables the system to lower its power usage; therefore the fan speed is reduced to achieve lowest operating noise.

The Keyboard

Your notebook's keyboard has all the functions of a normal AT-compatible keyboard plus some extras:

Typewriter

These keys correspond to a typewriter's keys.

Function keys

In many operating systems (and applications), special functions are available via these keys. You can find more detailed information on this in the relevant handbooks.

Special keys

These keys (and key combinations) are used for controlling various hardware functions.

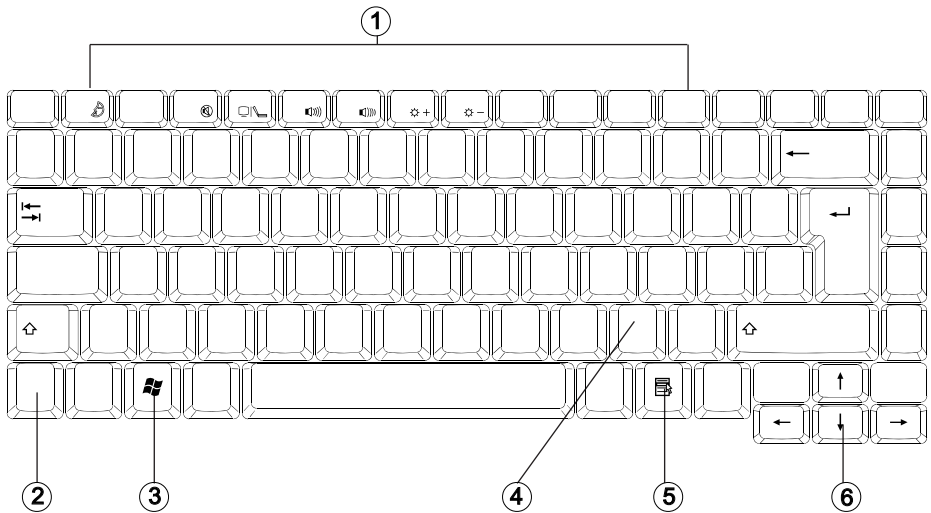

Fig. 13

- (1) Function keys – for more on functions, see table 2 (hot keys)
- (2) Fn key
- (3) Microsoft® Windows® key
- (4) Numerical keypad (press Num Lock key to activate this field)
- (5) Microsoft® Windows® key
- (6) Arrow keys

The TouchPad

The system automatically sets up the integrated TouchPad. If you are using Microsoft® Windows®, no driver needs to be installed for the basic functions. If you wish to use the advanced functions, you can find the driver to activate the function on the Utility CD. To do this, please follow the instructions in the "Installation Instructions" section.

- (1) Scroll field – works like a mouse wheel
- (2) Left "mouse" button
- (3) Right "mouse" button
- (4) Sensor field

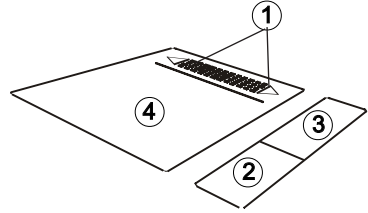

Note for left-handed users: most operating systems enable reversal of the mouse buttons.

Fig. 14

The TouchPad - Operation

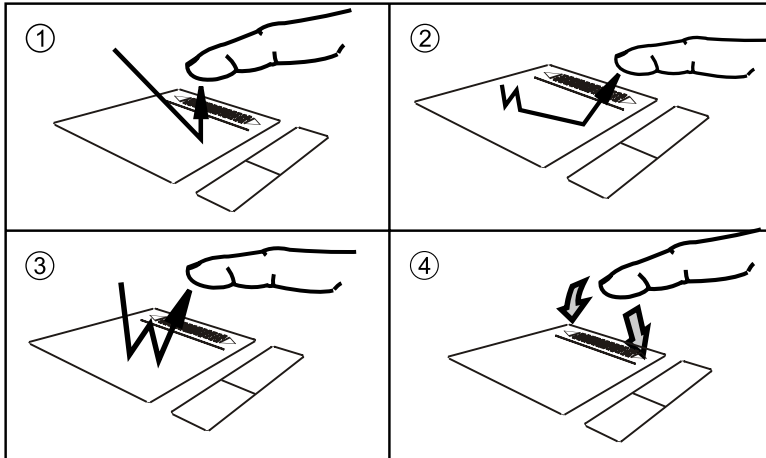

- (1) Select
- (2) Select, drag and drop
- (3) Double-click – to execute/ open files
- (4) Scrolling

When using the TouchPad, make sure it as well as your finger are clean and dry. The TouchPad reacts to finger movements. The lighter it is touched, the better it reacts. Pressing hard will not increase its accuracy.

The CD-ROM/DVD Drive

To insert a CD, press the eject button on the front side of the drive.

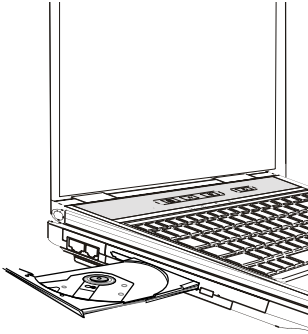

Fig. 15

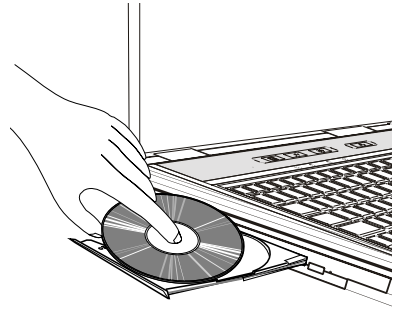

Fig. 16

Place a CD onto the spindle with the label side facing up and push it gently down onto the spindle.

Push the CD tray back in until it locks into place. The CD is now ready to read.

Some CDs have an autostart function. This means that installation programs or music CDs automatically run after you place them in the drive.

The PC Card Slot

The computer is provided with a PC card slot. This is a PCMCIA 3.3 V/5 V slot, Type II. To insert a PC card, push it into the slot until it locks into place. .

Set the connection you require (e.g. network connection).

You can also consult the documents for the relevant card

To remove the card, push the eject button next to the slot. The button will pop outwards. Pressing the slot again releases the PC card.

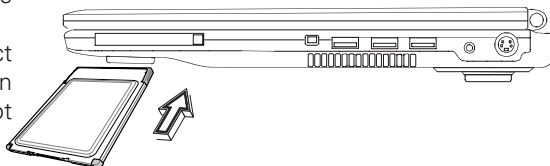

Fig. 17

The Memory Card Slot

The computer is provided with a combination slot. This slot accepts Memory Sticks (MS), MS Pro, SD (Secure Digital) and MMC (Multimedia card) cards.

Insert these cards into the slot holding the printed side upwards. After the card is inserted correctly into place, it is recognized as an additional drive. The data on the card can then be accessed.

To remove it, simply pull the card out.

Never remove the card while data is being read from or written to the card!

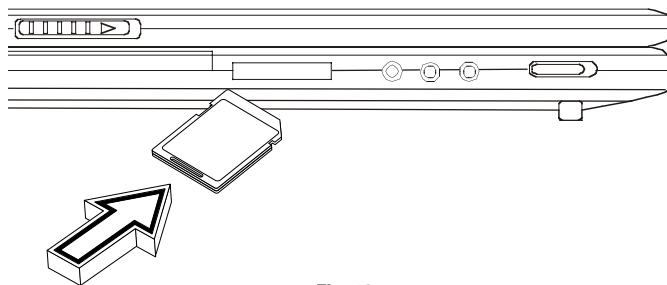

Fig. 18

The Data/Fax Modem

The system automatically sets up the integrated analog modem. To use the modem functions, connect the modem socket to an analog telephone socket (not ISDN) using the telephone cable.

Proper use:

The modem can be connected to all analog sockets (TBR 21) in Europe.

It is to be used solely for data communication purposes.



Do not attempt to connect the modem to an ISDN telephone socket! This would result in serious damage to the device.

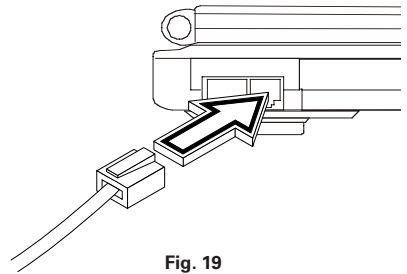

Fig. 19

The LAN Port

The built-in network adapter enables your computer to connect to the Internet via a 10/100 Mbps network or DSL.

The connection is made via an Ethernet network cable and RJ-45 connectors. These are inserted on the back of the computer and into an available network hub or DSL socket.



Under no circumstances should you confuse a network cable RJ-45 connector with an ISDN connector! NEVER attempt to connect the LAN adapter to an ISDN telephone socket! This would result in serious damage to the device.

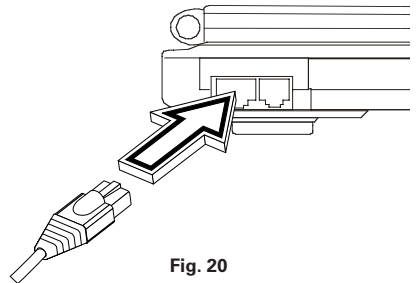

Fig. 20

Installation Instructions

Restoring the Drivers

Your system is supplied in a preloaded condition. This means that all the data and drivers that the system requires are already on the hard disk. In case you erase and/or format your hard disk drive, the system drivers are stored on the Utility CD supplied with the computer. After reinstalling the operating system (for example, with the Recovery CD), this allows you to restore your notebook to a usable condition.

The Utility CD

The Utility CD will run automatically after you place it in the drive. If this is not the case, you can run the CD as follows: select <My Computer"> <CD Drive> and then the "utility.exe" file.

You can select the driver that you want to install in the "Drivers" section. Recommended: All of the drivers listed from top to bottom.

In addition, you can later install the advanced functions you require in the "Utility" section.

When using the Utility CD, please follow the menu instructions.

Setting the Resolution

After installation of the graphics driver, you can set the resolution to the desired size (e.g. 1024 × 768).

You do this in the following way:

Right-click on any free area of the desktop. Select <Properties>.

In the Display Properties window, click the Settings tab.

Here you can set the slider to a resolution you find comfortable.

Click <Apply> to set the resolution.



Specifications

Processor and Platform

- Intel® Celeron® M 1.3 GHz to 1.5 GHz
- Intel® 855GME + ICH4M chipset

RAM

- Main memory expandable to 1 GB DDR SDRAM
(Only allow qualified service personnel to expand the main memory)
- Two PC2100/PC2700 (DDR 266/333) SODIMM sockets

Display and Video

- 15.0 inch XGA TFT display. Supported resolution 1024 × 768 with up to 16,7 million colors.
- Intel® Integrated Extreme Graphic2 2D / 3D graphics accelerator – AGP4X support
- Simultaneous LCD/external monitor
- External monitor:
Supports up to 1600 × 1200, 16.7 million colors, 85 Hz
- S-Video output

Storage Capacity

- One E-IDE hard disk drive (2.5"; 9.5 mm)
- One internal optical drive
- One memory card slot

Audio

- AC '97 compatible stereo sound with 3D sound effects
- Built-in stereo loudspeakers

Modem

- High-speed 56 Kbps V.90/92 fax/data software MCD modem

LAN

- Built-in fast Ethernet function for 10Base-T and 100Base-TX
- MSI MS-6833 mini PCI module for wireless network 802.11 b+g (optional)

Input Devices

- 86-key Microsoft® Windows® keyboard
- Ergonomically positioned TouchPad with scroll field
- Quick launch keys

Ports

- One 15-pin VGA port
- S-video (TV-out) output connector
- One Headphone/SPDIF socket
- One microphone input socket
- One Line In socket
- Three USB ports (v2.0)
- One standard telephone socket (RJ-11)
- One standard network socket (RJ-45)
- One DC IN socket
- One IEEE1394 i.Link port
- One Type II PC card slot

Power Supply

- **Main battery Li-Ion 4400 mAh, 48 Watt**
- AC power adapter 100-240 V, AC 50-60 Hz, 65 Watt
- Recharging System OFF: 3 hours
 System ON: 4.5 hours
- Fully-supported ACPI Power Management, suspend to Disk, suspend to RAM

Operating System

- O/S Microsoft® Windows® 2000/XP

Other Data

- Dimensions 272 (D) × 333 (W) × 25.3 – 33.1 (H) mm
- Weight approx. 2.9 kg (depending on model/configuration)
- Operating temperature: 5 to 30°C
- Operating humidity: 20 to 90 % RH
- Storage temperature: -20 to 50°C



Fault Diagnosis and Troubleshooting

If a problem occurs while working with your computer, first of all try using the following information to solve the problem. If the problem cannot be solved in this way, you can find additional information in the advanced service handbook (on the device drivers and utilities CD-ROM). If the problem persists, switch off the system for several minutes and then restart it. You will lose all unsaved data, but the system may work properly again. Subsequently contact your dealer or customer support agent.

Despite pressing the power switch the computer remains switched off.

Possible cause of the problem:

- The battery is missing or is incorrectly installed.

Note:

- The power on LED is not lit.

Troubleshooting:

- Make sure that the battery is in the battery compartment and is inserted properly.
- Check that the battery terminals are making direct contact.
- Connect your notebook to the power adapter so that the battery (if present) can recharge.

Possible cause of the problem:

- Battery level low.

Note:

- The battery display LED flashes.

Troubleshooting:

- Operate the computer using the power adapter. If the system does not immediately start up, switch off the computer and then restart it.

The screen is not working.

Possible cause of the problem:

- The energy saving mode is activated.

Note:

- The suspend LED flashes.

Troubleshooting:

- Press the on/off button.

Possible cause of the problem:

- The screen settings are incorrect.

Troubleshooting:

- Press the spacebar, several times if necessary.
- If an external monitor is connected, switch it on.

Possible cause of the problem:

- *In the System Settings, a screen type other than the existing one has been set.*

Troubleshooting:

- Press the Fn + F4 key combination.
- If an external monitor is connected, connect this to a power source and switch it on. Also check the brightness and contrast settings.

Dualview does not work.

Note:

- This notebook type does not support dualview because of the hardware specification.

The system stops working.

Possible cause of the problem:

- An energy saving function has been activated.

Note:

- The screen switches itself off.

Troubleshooting:

- Press any key, or press the on/off button if none of the status LEDs are lit.

Possible cause of the problem:

- A software error has caused a system crash.

Troubleshooting:

- Additional information is available in the operating system handbook.
- If you cannot remedy the problem, restart the system. You will lose any unsaved data! If this doesn't work either, briefly switch off the computer and then switch it back on again.



Each time the system starts, it carries out a self-test (POST). If an error occurs, an error message appears, briefly describing the problem.

Index

- A**
Accuracy 77
ACPI power saving system 69
Arrow keys 76
- B**
Battery 53, 56, 63, 66, 72, 73, 87
Battery slot 66
- C**
Charging times 66
Cleaning 55, 56
Cold restart 68
Color depth 68
Ctrl + Alt + Del 68
- D**
Data/Fax Modem 80
Display 65, 74, 68, 69, 83, 87
- E**
Emergency release 71
Energy consumption 69
Energy settings 68
External monitor 72, 83, 87, 88
- F**
Finger movements 77
Fn key 74, 76
Function keys 76
- G**
Garbage collection service 55
- H**
Headphones 71
Hibernate 69
Household waste 53, 55
- I**
IEEE 1394 71
Infrared 71, 84
ISDN connector 80
- K**
Keyboard 65, 76
Keys 65, 74, 65, 74
- L**
LAN Port 80
LCD display 65, 74
Line In 71, 84
Liquid 56
Loudspeakers 65, 71
- M**
Memory card 71
Microphone 71
Modem socket 80
Moisture 55
- N**
Network 57, 61, 71, 79, 80, 83, 84
Network adapter 80
- O**
Operating state 69
Operating system 68, 69, 76, 77
Original packaging 63
- P**
PC card 69, 71, 79, 84
Port replicator 72
Power adapter 55, 66, 67, 69, 71, 84, 87
Power button 65
Power cable 56, 67
Power supply 55, 56, 67, 69
Printer 72
- Q**
Qualified service personnel 55, 56, 83
Quick launch keys 65, 84
- R**
Release catch 65
Resolution 68, 81, 83

S

Scroll Pad	65
Shipping contents	63
Shocks/Vibrations	55
Special keys	76
Standby.....	69
Status LEDs.....	65
Sunlight.....	55
Switch on	68
System crash	68, 88

T

TouchPad	65, 77, 84
Typewriter.....	76

V

Voltage.....	52, 67
--------------	--------

W

Warm restart	68
Warranty	52